



CT 400 and CT410 Desk Top Printers



Operator and Technical Reference Manual

SATO America, Inc.
10350-A Nations Ford Rd.
Charlotte, NC 28273
Main Phone: (704) 644-1650
Technical Support Hotline: (704) 644-1660
Fax: (704) 644-1661
www.satoamerica.com

© Copyright 2000
SATO America, Inc.

Warning: This equipment complies with the requirements in Part 15 of FCC rules for a Class A computing device. Operation of this equipment in a residential area may cause unacceptable interference to radio and TV reception requiring the operator to take whatever steps are necessary to correct the interference.

All rights reserved. No part of this document may be reproduced or issued to third parties in any form whatsoever without the express permission of SATO America, Inc. The materials in this document is provided for general information and is subject to change without notice. SATO America, Inc. assumes no responsibilities for any errors that may appear.

PREFACE

CT SERIES PRINTER OPERATOR'S MANUAL

The CT Series Printer Operator's Manual contains basic information about the printer such as setup, installation, cleaning and maintenance. It also contains complete instructions on how to use the operator panel to configure the printer. The following is a brief description of each section in this manual.

SECTION 1. PRINTER OVERVIEW

This section contains a discussion of the printer specifications and optional features.

SECTION 2. INSTALLATION AND CONFIGURATION

This section contains instructions on how to unpack and set up the printer, load the labels and ribbon, and how to use the operator panel to configure the printer.

SECTION 3. CLEANING AND MAINTENANCE

This section contains instructions on how to clean and maintain the printer.

SECTION 4. PROGRAMMING

This section introduces the SATO printer programming language. It contains the commands that are used with the printer to produce labels with bar codes, alphanumeric data and graphics.

SECTION 5. INTERFACE SPECIFICATIONS

This section contains the printer's interface specifications, which include detailed information on how to properly interface your printer to the host system.

SECTION 6. TROUBLESHOOTING

This section contains troubleshooting procedures to follow in the event you have printer problems.

APPENDICES

APPENDIX A: Command Code Quick Reference

APPENDIX B: Bar Code Specifications

APPENDIX C: Custom Characters and Graphics

TABLE OF CONTENTS

SECTION 1. PRINTER OVERVIEW

Introduction	1-1
General Printer Specifications	1-2
Character Fonts	1-4
Bar Codes	1-5
Physical	1-6
Optional Accessories	1-7

SECTION 2. INSTALLATION AND CONFIGURATION

Introduction	2-1
Unpacking	2-2
Setting Up the Printer	2-3
Loading Ribbon (CT4XXTT Only)	2-5
Loading Media	2-7
Label Sensing	2-10
Operator Panel	2-11
Rear Connector Panel	2-12
Configuration Panel	2-13
Offset	2-16
Potentiometer Adjustments	2-16
Hex Dump Diagnostic Label	2-19
Print Test Labels	2-20

SECTION 3. CLEANING AND MAINTENANCE

Introduction	3-1
Procedures	3-1
Adjusting the Print Quality	3-1
Darkness	3-1
Print Speed	3-2
Cleaning the Print Head, Platen and Rollers	3-2
Replacing the Print Head	3-3
Cleaning the Sensors	3-5

SECTION 4. PROGRAMMING

Introduction	4-1
The SATO CT Programming Language	4-1
Protocol Control Codes	4-2
Using Basic	4-2
The Print Area	4-4
Rotated Fields	4-6
Command Default Settings	4-6
Command Codes	4-6
Bar Codes	4-9
Bar Codes, Expansion	4-14
Bar Codes, Variable Ratio	4-15
Base Reference Point	4-17
Characters, Custom Designed	4-29
Character Expansion	4-21
Character, Fixed Spacing	4-23
Character Pitch	4-24
Character, Proportional Spacing	4-26
Clear Print Job(s) and Memory	4-27
Continuous Forms Printing	4-28
Copy Image Area	4-29
Cut Job	4-31
Cut	4-32
Cut Last	4-33
Fonts, U, S, M, OA, OB, XU, XS and XM	4-34
Font/Graphic Recall	4-36
Font, Raster	4-37
Fonts, Vector	4-38
Fonts, WB,WL, XB and XL	4-40
Form Overlay Recall	4-42
Form Overlay Store	4-43
Graphics, Custom	4-44
Job ID Store	4-46
Journal Print	4-47
Lines and Boxes	4-48
Job Name	4-50
Label/Tag Select	4-51
Line Feed	4-52
Media Size	4-54
Off-Line	4-55
Postnet	4-56
Print Darkness	4-57
Print Position	4-58
Print Quantity	4-60
Print Speed	4-61
Repeat Label	4-62
Replace Data (Partial Edit)	4-63
Reverse Image	4-65
Rotate, Fixed Base Reference Point	4-67

Sequential Numbering	4-68
Start/Stop Label	4-70
Two-Dimensional Symbols	4-71
Data Matrix, Data Format	4-72
Data Matrix, Data Print	4-74
Dat Matrix Sequential Numbering	4-75
Maxicode	4-77
PDF417	4-79
Printer Configuration Commands	4-81
Protocol Codes	4-82
Printer Setting	4-83
Print Mode	4-86
Print Type	4-87
Pitch Offset	4-88
Sensor Type	4-89
Serial Interface Parameters	4-90

SECTION 5. INTERFACE SPECIFICATIONS

Introduction	5-1
Interface Types	5-1
The Receive Buffer	5-2
RS232C Serial Interface	5-3
IEEE 1284 Parallel Interface	5-3
Optional RS232 Interface	5-5
General Specifications	5-5
Electrical Specifications	5-5
Pin Assignments	5-5
Ready/Busy Flow Control	5-6
X-On/X-Off Flow Control	5-57
Optional Universal Serial Bus (USB) Interface	5-7
Optional Local Area Network Interface	5-8
Bi-Directional Communications	5-8

SECTION 6. TROUBLESHOOTING

Initial Checklist	6-1
Using the IEEE 1284 Parallel Interface	6-1
Using the RS232C Serial Interface	6-3
Error Signals	6-4

APPENDICES

APPENDIX A: Command Code Quick Reference

APPENDIX B: Bar Code Specifications

Bar Code Symbolologies	B-1
Codabar	B-2
Code 39	B-3
Interleaved Two of Five (I 2/5)	B-4
UPC-A/EAN-13	B-5
EAN-8	B-6
Industrial Two of Five	B-8
Matrix Two of Five	B-9
Code 128	B-10
MSI	B-11
Code 93	B-12
UPC-E	B-13
Bookland (UPC/EAN Supplements)	B-14
UCC-128	B-15
Postnet	B-17
Data Matrix	B-18
Maxicode	B-20
PDF417	B-21
Code 128 Character Table	B-22

APPENDIX C: Custom Characters and Graphics

Custom Designed Characters Example	C-1
Custom Graphics Example	C-4
PCX Graphics Example	C-8

SECTION 1.

PRINTER OVERVIEW

INTRODUCTION

The SATO CT Series Thermal Transfer Printers are complete, high-performance on-site labeling systems. All printer parameters are user programmable using software commands or the utility program provided. All popular bar codes and 15 human-readable fonts, including a vector font and two raster fonts, are resident in memory providing literally thousands of type styles and sizes. Additional fonts can be downloaded into memory.

The Operator's Manual will help you understand the basic operations of the printer such as setup, installation, configuration, cleaning and maintenance.

The major differences in the CT400 and the CL410 printers is the resolution of the head. The CT400 with its 203 dpi head provides an economical labeling solution for most applications. It can print labels up to four inches wide. The CT410's higher 305 dpi resolution provides greater detail for graphics and small point size text.

The CT Series printers use a subset of the standard SATO Command Language. The CT400 and CT410 share the same command set, the only differences are the allowable values representing the print positions on the label. These values are specified in "dots" and will vary depending upon the resolution of the printer and the amount of memory available for imaging the label. The allowable range for each printer is specified in a table for those command codes.

This commonality makes it very easy to convert labels from one CT printer to another without having to create an entirely different command stream. There are some caveats that must be observed though to compensate for the different resolution print heads. The effect of the different printer resolutions are best illustrated by taking a label designed for a 203 dpi printer and sending the command stream to its 305 dpi counterpart. The label printed will be an exact two-thirds scale, including the fonts, bar code dimensions and line lengths/widths. The only exceptions are PostNet and Maxicode which have only one legal size and the printer resolution is automatically compensated for by the printer. Conversely, a label designed for a 305 dpi printer and sent to its 203 dpi cousin will be one-third larger. It probably will be "truncated" if the label size is larger than the maximum allowable for the printer.

The following general information is presented in this section:

- General Printer Specifications
- Optional Accessories

GENERAL PRINTER SPECIFICATIONS

SPECIFICATION	CT400	CT410
PRINT		
Method	Direct or Thermal Transfer	
Speed (User Selectable)	2 to 6 ips 50 to 150 mm/s	2 to 4 ips 50 to 100 mm/s
Print Module (Dot Size)	.0049 in. .125 mm	.0033 in. .083 mm
Resolution	203 dpi 8 dpmm	305 dpi 12 dpmm
Maximum Print Width	4.1 in. 104 mm	
Maximum Print Length	15.6 in. 400 mm	
MEDIA		
Minimum Width	.90 in. (23 mm)	
Minimum Length	.60 in. (15 mm)	
Maximum Width	4.6 in. (118 mm)	
Type	Die Cut Labels, Fan-Fold, Tag Stock or Continuous	
Caliper	0.003 to .0075 in. (0.08 to 0.19 mm)	
Roll OD (max)	4.3 in. (110 mm), Face-Out Wind	
Core ID (min)	1.5 in. (40 mm)	
SENSING		
See-Thru for labels or tags	Fixed, 0.25" (6.3 mm) from left label edge	
Reflective Eye-Mark	Fixed, 0.20" (5 mm) from left label edge	
Continuous Form	Sensor not used	
RIBBON		
Maximum Width	4.4 in. (111 mm)	
Length	325 ft. (100 m)	
Core ID	0.5 in. (12.7 mm)	
Thickness	4.5 micron, Face-Out Wind	

All specifications subject to change without notice.

SPECIFICATION	CT400	CT410
CONTROLS AND SIGNALS		
On-Line LED	Green	
Power LED	Green	
Error LED	Red	
LED Display Panel	7 Segment Single Character	
On/Off-Line Switch	Front Panel	
Label Feed Switch	Front Panel	
Power On/Off Switch	Front Panel	
POTENTIOMETER ADJUSTMENTS		
Pitch Offset/Print Darkness	Front Panel	
Reflective Sensor Adjustment	Front Panel	
See-thru Sensor Adjustment	Front Panel	
INTERFACE CONNECTIONS		
Parallel (Standard)	IEEE 1284	
Serial (Option)	RS232C (9600 to 57.6K bps) Hardware Flow Control (Ready/Busy) Software Flow Control (X-On/X-Off) Bi-directional Status	
USB (Option)	USB Specification Version 1.0	
PROCESSING		
CPU	32 Bit RISC	
EEPROM	8KB	
SDRAM	8MB	
Flash ROM	2MB	
Flash ROM Option	8MB	
Receive Buffer	2.95MB	

All specifications subject to change without notice.

CHARACTER FONTS

SPECIFICATION	CT400	CT410
MATRIX FONTS		
U Font	(5 dots W x 9 dots H)	
S Font	(8 dots W x 15 dots H)	
M Font	(13 dots W x 20 dots H)	
XU Font	(5 dots W x 9 dots H) Helvetica	
XS Font	(17 dots W x 17 dots H) Univers Condensed Bold	
XM Font	(24 dots W x 24 dots H) Univers Condensed Bold	
OA Font	(15 dots W x 22 dots H) OCR-A	(22 dots W x 33 dots H) OCR A
OB Font	20 dots W x 24 dots H) OCR-B	(30 dots W x 36 dots H) OCR B
AUTO SMOOTHING FONTS		
WB ⁽¹⁾	WB Font (18 dots W x 30 dots H)	
WL ⁽¹⁾	WL Font (28 dots W x 52 dots H)	
XB	XB Font (48 dots W x 48 dots H) Univers Condensed Bold	
XL	XL Font (48 dots W x 48 dots H) Sans Serif	
VECTOR FONT		
	Proportional or Fixed Spacing Font Size 50 x 50 dots to 999 x 999 dots Helvetica, 10 Font Variations	
RASTER FONTS		
A Font ⁽¹⁾	CG Times	
B Font ⁽¹⁾	CG Triumvirate	
DOWNLOADABLE FONTS		
	TrueType Fonts with Utility Program	
CHARACTER CONTROL		
	Expansion up to 12X in either the X or Y coordinates Character Pitch control Line Space control Journal Print facility 0°, 90°, 180° and 270° Rotation	

(1) Not available on early models.

All specifications subject to change without notice.

BAR CODES

SPECIFICATION	CT400	CT410
SYMBOLOLOGIES		
	Bookland (UPC/EAN Supplemental) EAN-8, EAN-13 CODABAR Code 39 Code 93 Code 128 Interleaved 2 of 5 Industrial 2 of 5 Matrix 2 of 5 MSI POSTNET UCC/EAN-128 UPC-A and UPC-E Data Matrix Maxicode PDF417 Micro PDF Truncated PDF	
Ratios	1:2, 1:3, 2:5 User definable bar widths	
Bar Height	4 to 600 dots, User programmable	
Rotation	0°, 90°, 180° and 270°	
OTHER FEATURES		
Sequential Numbering	Sequential numbering of both numerics and bar codes	
Custom Characters	RAM storage for special characters	
Graphics	Full dot addressable graphics, SATO Hex/Binary and PCX ⁽¹⁾ format	
Form Overlay	Form overlay for high-speed editing of complex formats.	

(1) Not available on early models.

All specifications subject to change without notice.

PHYSICAL

SPECIFICATION	CT400	CT410
DIMENSIONS		
Wide	7.8 in. (198 mm)	
Deep	9.1 in. (230 mm)	
High	6.5 in. (181 mm)	
WEIGHT	6.6 lbs (3 Kg)	
POWER REQUIREMENTS		
Voltage	110 V (±10 %) 220V (±10 %) 50/60 Hz (±1%)	
Power Consumption	150W Operating at 30% density	
ENVIRONMENTAL		
Operating Temperature	41° to 104°F (5° to 40°C)	
Storage Temperature	-0° to 104°F (-20° to 40°C)	
Operating Humidity	30-80 % RH, non-condensing	
Storage Humidity	20-80% RH, non-condensing	
Electrostatic Discharge	8KV	
REGULATORY APPROVALS		
Safety	UL, CSA	
RFI/EMI	FCC Class B	

All specifications subject to change without notice.

OPTIONAL ACCESSORIES

ACCESSORY	CT400	CT410
LABEL CUTTER	Internal option allowing labels to be cut at specified intervals. Controlled through programming. Factory installed only.	
LABEL DISPENSER	Internal option allowing labels to be peeled from backing for immediate (on demand) application. Factory installed only.	
LABEL REWINDER	External accessory rewinds labels onto a roll after they are printed.	
SERIAL INTERFACE	High Speed RS232 Interface option, 9600 to 57.6KB. Factory installed only.	
ETHERNET INTERFACE	TCP/IP Protocol Interface option. Factory installed only.	
USB INTERFACE	Universal Serial Bus Interface option. Factory installed only.	
COAX/TWINAX INTERFACE	External Coax/Triax I/F Interface accessory. Coax I/F emulates an IBM 3287-2 printer with a standard Type A BNC connector. Twinax I/F emulates IBM 5224, 5225, 5226 or 4214 printers with auto-terminate/cable-thru capabilities.	

All specifications subject to change without notice.

This page left intentionally blank.

SECTION 2. INSTALLATION AND CONFIGURATION

INTRODUCTION

This section is to assist you in taking the CT Series printer from the shipping container to the application environment.

The following information is provided in this section:

- Unpacking and Parts Identification
- Setting Up the Printer
- Loading Labels or Tags
- Loading the Ribbon (CT4XXTT only)
- Control Panel
- Printer Configuration

UNPACKING

Consider the following when unpacking the printer:

- The box should stay upright.
- Lift the printer out of the box carefully.
- Remove the plastic covering from the printer.
- Remove the accessory items from their protective containers.
- If the printer has been stored in a cold environment, allow it to reach room temperature before applying power.
- Set the printer on a solid flat surface. Inspect the shipping container and printer for any signs of damage that may have occurred during shipping.

In addition to this manual, verify that you have the following materials when unpacking:

Printer

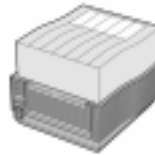

Power Module
AC Power Cord



Ribbon/Core



CD-ROM



SETTING UP THE PRINTER

Consider the following when setting up the printer/

- Locate a solid flat surface with adequate room to set the printer. Make sure the Power Module can be located so that the power connecting cable can be attached to the printer and the AC Power Cable can be connected to an AC power outlet.
- The location should be near the host or computer terminal. The maximum distance is:
 - 10 feet for the Parallel interface. To fully utilize the capabilities of the printer, a cable meeting IEEE 1284 specifications must be used.
 - 18 feet for the optional Serial RS232 Interface.
 - 10 feet for the optional USB interface without hub.
 - the optional 10baseT Ethernet Interface depends upon the LAN cabling.
- For information on interfacing the printer to a host system, see Section 5. Interface Specifications.

Follow these steps to set up your printer:

1. Make sure the power switch on the Operator Panel is in the OFF (0) position and place the Power Module in a safe and secure location, taking into consideration the location of the AC outlet and the host in relation to the printer.
2. Connect the Input Power connector to the printer. This connector is keyed and must be turned approximately 3/4 turn clockwise to secure it to the printer.
3. Connect the AC Power Cable to the proper AC Outlet supply.
4. Connect the interface cable to the host system. A parallel IEEE1284 interface cable must be used to realize the high data transfer rate of the printer's parallel port. If an optional interface is installed, the appropriate cable should be used.
5. Load the ribbon and media following the instructions in this section.
6. Configure the printer for label width and operating mode using the instructions in this section.

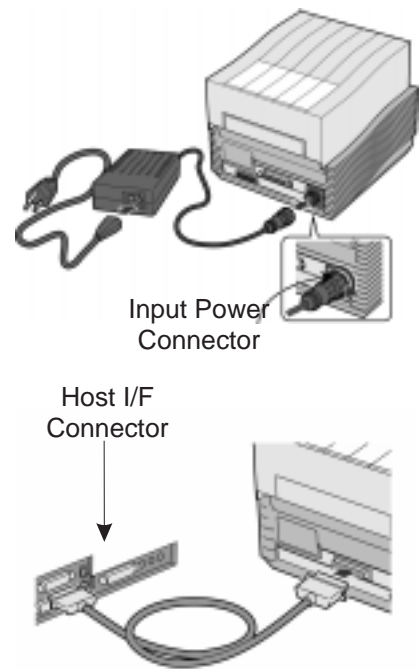

Section 2. Installation and Configuration

7. Apply power to the printer by placing the AC Power switch in the ON (1) position.
8. Print a test label to verify the printer is set up and operating correctly.

LOADING RIBBON (CT4XTT only)

The SATO CT Series ribbons come shrink-wrapped with a 12" (305 mm) leader pre-attached to a takeup core. There are three widths of ribbon available for the CT Series printers; 4.3" (110 mm), 3" (76 mm) and 1.75" (45 mm).

1. Remove power from the printer.
2. Open the **Top Cover** by pressing on cover the release points located on each side of the printer. This releases the cover latch and allows it to swing upward on the rear mounted hinge points.
3. Release the **Print Head Assembly** by pressing the **Head Latch** to the rear. This allows the assembly to rotate upward to the left allowing easy access for ribbon routing. Rotate the assembly until it is vertical.
4. Press down on the **Ribbon Assembly Latch**. This allows the **Paper Roller** to swing downward for ribbon routing.
5. Press down on the **Ribbon Positioning** button while simultaneously pulling upward on the **Ribbon Spindle Unit**. The **Ribbon Spindle Unit** should slide off.
6. Remove the shrink wrap from the ribbon and unwind approximately 6" of the leader. Press the **Ribbon Supply** core all the way onto the rear spindle of **Ribbon Spindle Unit**. Press the attached take-up core on the front spindle. Make sure each of the cores is fully seated on the spindles and there is enough ribbon leader to go down around the print head.

Note: CT Series ribbons are wound face (ink side) out. Make sure the dull (ink)

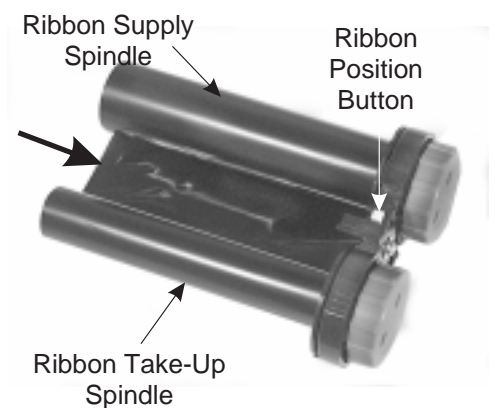
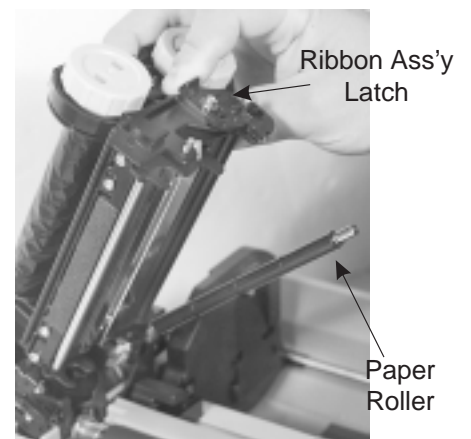
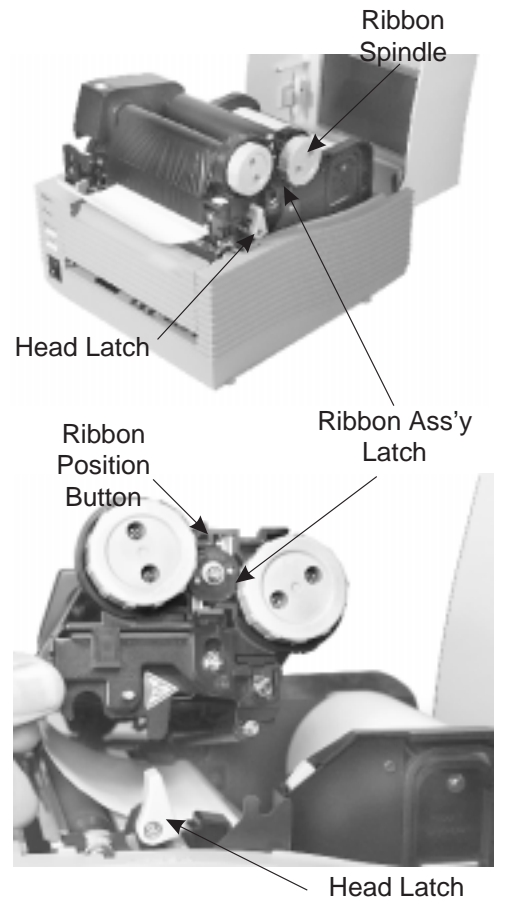

side of the ribbon will be in contact with the paper and the supply core is on the rear spindle.

7. Slide the **Ribbon Spindle Unit** over the **Ribbon Drive Spindles** until the **Head Positioning Latch** snaps into position. The first position corresponds to a 4.3" ribbon width. If you are using a narrower ribbon, press the **Head Position Latch** while sliding the Ribbon Spindle Unit to the correct position. There are three latch positions, one for a 4.3" wide ribbon, one for a 3" wide ribbon and one for a 1.75" wide ribbon.

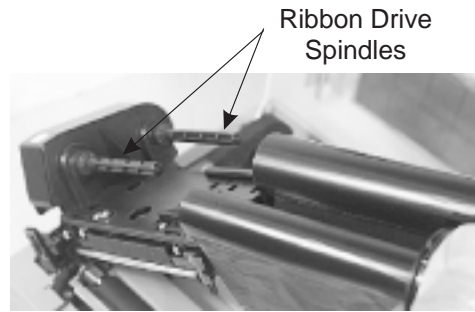

8. The ribbon should be center justified (i.e., the center of the ribbon roll should be aligned with the center of the print head). If it is not, reposition the **Ribbon Spindle Unit** on the **Drive Spindles** until the **Ribbon Position Latch** is in the correct position.



9. Route the ribbon leader under the print head and between the **Ribbon Assembly** and the **Paper Roller**. Rotate the take-up spindle until the leader is completely wound onto the take-up core.
10. Push the **Ribbon Assembly Latch** to the up or locked position. Rotate the **Paper Roller** upward and latch it by pushing the **Ribbon Assembly Latch** into the upward position.

11. Latch the **Print Head Assembly** in the closed position by pushing downward on the "PUSH" tabs on both sides of the assembly until it latches in position.

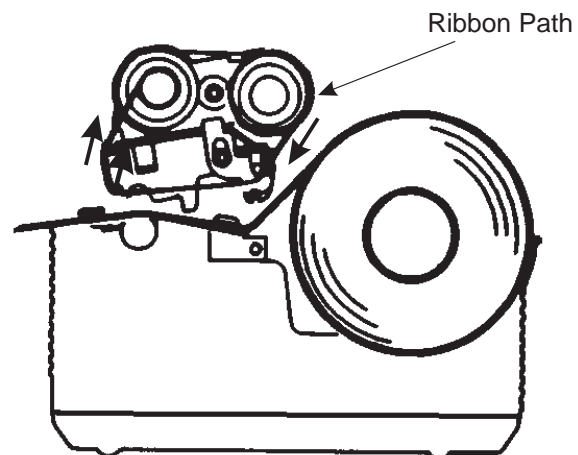

LOADING MEDIA

The CT Series printers can use die-cut labels, tag stock or continuous media. The media supply can be either roll or fanfold.

Roll Media

Roll media should be between 0.90" (23 mm) and 4.5" (115 mm) in width and wound face-out on a core with a minimum ID of 1.6" (40 mm).

1. Remove power from the printer by placing the **Power Switch** in the OFF (0) position.
2. Open the **Top Cover** by pressing on cover release points located on each side of the printer. This releases the cover latch and allows it to swing upward on the rear mounted hinge points.
3. Release the **Print Head Assembly** by pressing the **Head Latch** to the rear. This allows the assembly to rotate upward to the left allowing easy access for media routing. Rotate the assembly until it is vertical.
4. With the **Print Head Assembly** in the up position, press the **Paper Guide Release** while adjusting the **Paper Guides** until they allow a media roll to fit between them. A millimeter scale is molded into the case to provide a guide when making the adjustment. The **Paper Guides** are center justified and interact with each other so that each moves an equal distance.
5. Make sure the **Roll Holders** are in the released position. If they are not, lift up on each one and they will snap to the open position.
6. Unwind approximately 12" of label material from the roll. The labels should be wound face-out (printing side to the outside of the roll). Drop the roll in between the **Paper Guides** so that the labels

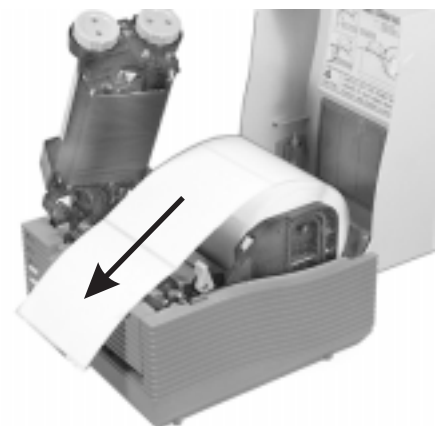
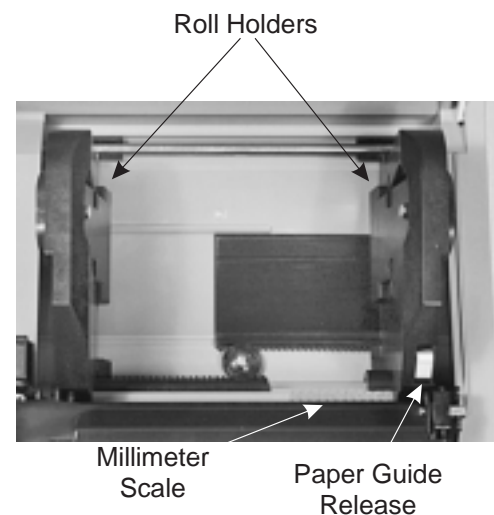
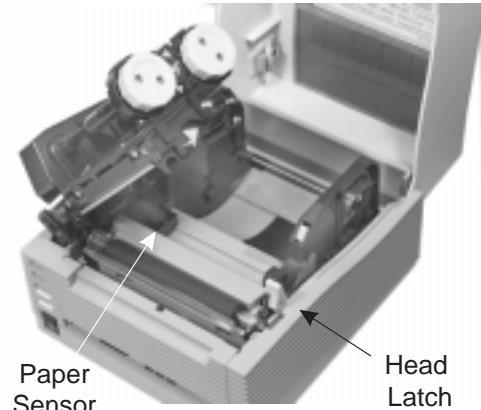

come off the top of the roll. The Paper Guides will automatically position the **Roll Holders** to suspend the roll.

7. Route the label material through the **Paper Sensor Assembly** and over the **Platen**. Note that the Sensor is part of the left **Label Roll Guide** so that the **Paper Sensor** is always positioned in the same location relative to the left edge of the label.

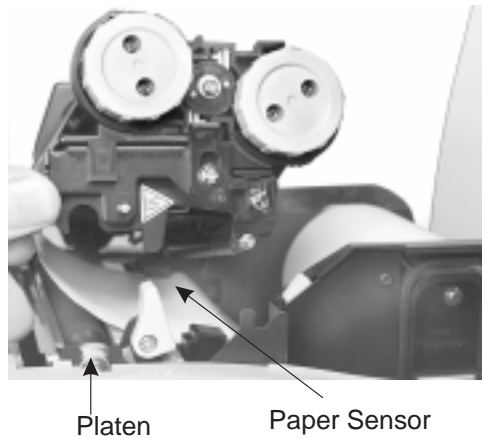

8. Close and latch the **Print Head Assembly**.
9. Press the **LINE** key so that the printer is in the OFF LINE mode and then press the **FEED** key. The label should advance to the next index (label gap or eye-mark) position.

Fanfold Media

1. Place the fanfold media behind the printer with the printing surface up.
2. Open the **Top Cover** by pressing on cover release points located on each side of the printer. This releases the cover latch and allows it to swing upward on the rear mounted hinge points.
3. Carefully break out the **Fanfold Access Panel** from the back of the **Top Cover**.
4. Release the **Print Head Assembly** by pressing the **Head Latch** to the rear. This allows the assembly to rotate upward to the left allowing easy access for ribbon routing. Rotate the assembly until it is vertical.

Break Out for
Fanfold Paper



5. With the **Print Head Assembly** in the up position, press the Paper Guide Release while adjusting the **Paper Guides** until they allow a media to fit between them. A millimeter scale is molded into the case to provide a guide when making the adjustment. The **Paper Guides** are center justified and interact with each other so that each moves an equal distance.
6. Route the label material through the **Sensor Assembly** and over the **Platen**.

Section 2. Installation and Configuration

7. Close and latch **Print Head Assembly**.
8. After loading the ribbon and media, it is recommended that you run a Test Print to make sure the labels and ribbon (for CX4XXTT only) are correctly loaded. See Section 2 for instructions on how to run test prints.

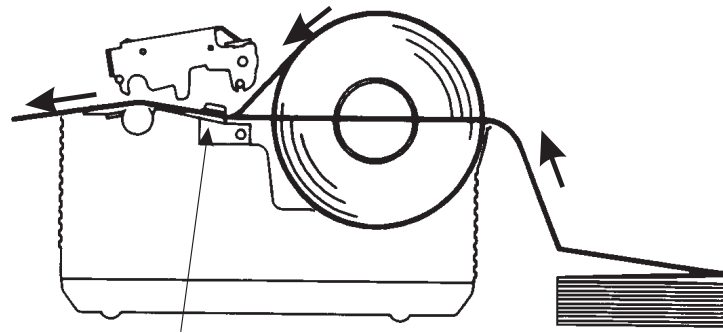

Route Paper under the Sensor

LABEL SENSING

The CT Series printers can use either label Gap (see-thru) or Eye-Mark (reflective) sensing. The Sensor Assembly is located on the left edge of the media and is automatically positioned by the Paper Guides.

The printer is shipped from the factory with the default sensing method set for label gap. The setting can be overridden by using the <ESC>IG command (Section 4) however it will be reset to the default when power is cycled. The default setting can be changed using the <ESC>PG command (Section 4) or the Printer Configuration Utility program on the CD-ROM.

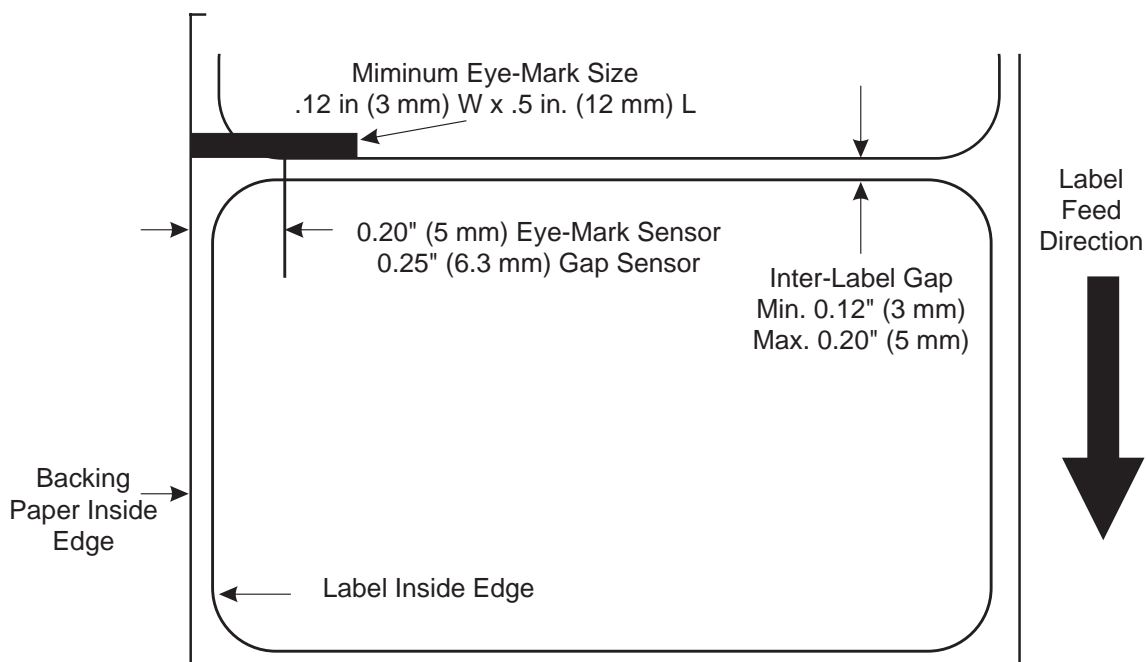

CT Series Printer Label Sensor Positioning

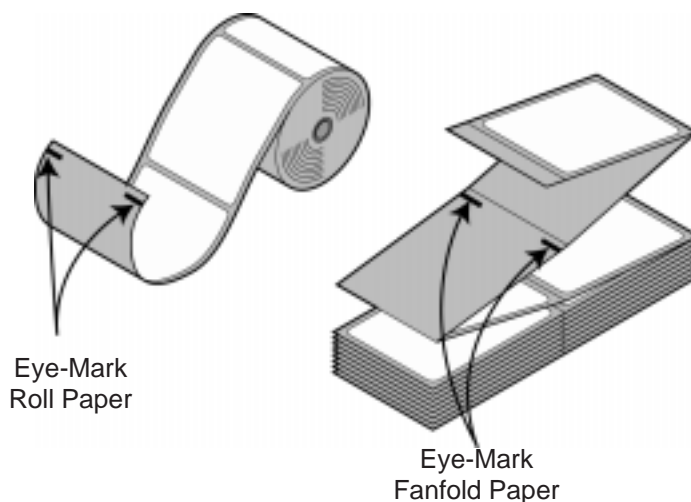

OPERATOR PANEL

The Operator Panel consists of three LED indicators and three switches.

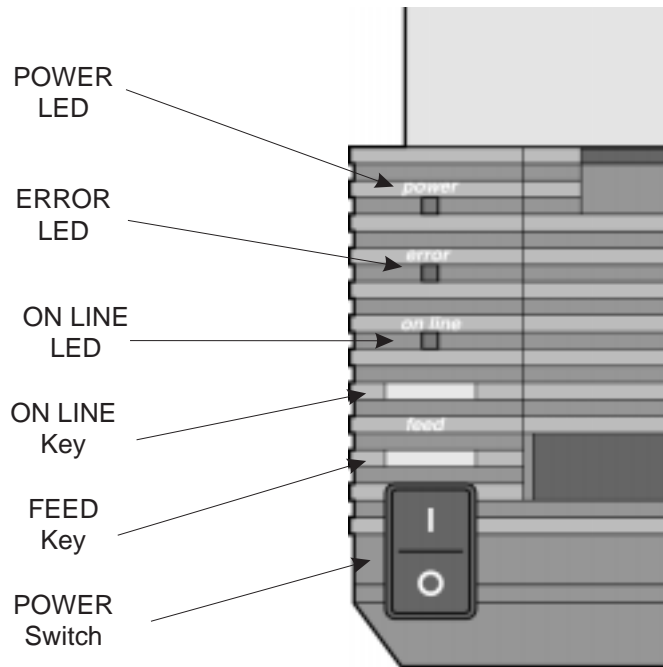

POWER

Green LED, illuminated when power is applied.

ERROR

Red LED, illuminated when there is a system fault such as an open print head.

ON LINE

Green LED, illuminated when the printer is ON LINE and ready to receive data. The printer is placed ON LINE and OFF LINE by toggling the ON LINE key.

ON LINE KEY

If the ONLINE LED is illuminated, pressing this switch will place the printer in the OFFLINE mode. Pressing the switch again will place the printer back in the ONLINE mode. If this switch is pressed while the printer is printing, the printing process is suspended. To resume printing, press this switch again. When the printer is ON LINE, it is ready to receive data from the host. When it is OFF LINE, the printer will not receive data from the host or print.

FEED KEY

Feeds one label when pressed in the OFFLINE mode. If this switch is held in the depressed position while power is applied, a printer status label will be printed.

POWER

A two position switch that applies power to the printer. When the "0" position is pressed, power is removed from the printer. When the "1" position is pressed, power is applied to the printer.

REAR CONNECTOR PANEL

All of the printer cable connectors are located on the Rear Connector Panel.

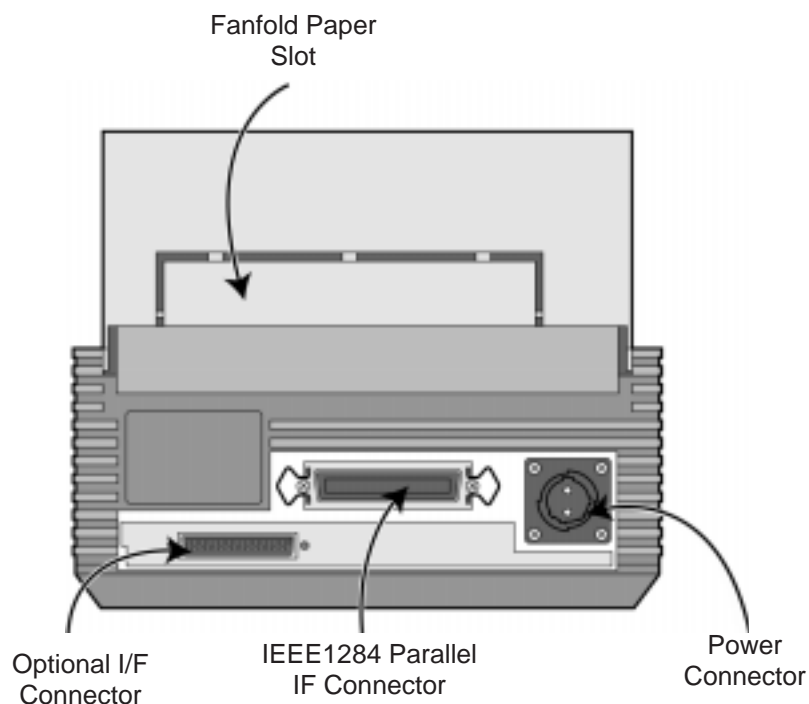

Power	DC Power input to the printer. From Power Module.
Parallel Interface	IEEE1284 Parallel Interface Connector..
Optional Interface (if Installed)	Connector for any installed optional interface.
Fanfold Paper Slot	Slot for fanfold paper. Panel must be removed to route fanfold paper into the printer.

CONFIGURATION PANEL

The Configuration Panel can be accessed by opening the Top Cover. It consists of an eight position DIP switch, three adjustment potentiometers and a seven segment LED Error display. Receptacles for connecting the Dispenser and Cutter options are also located on this panel.

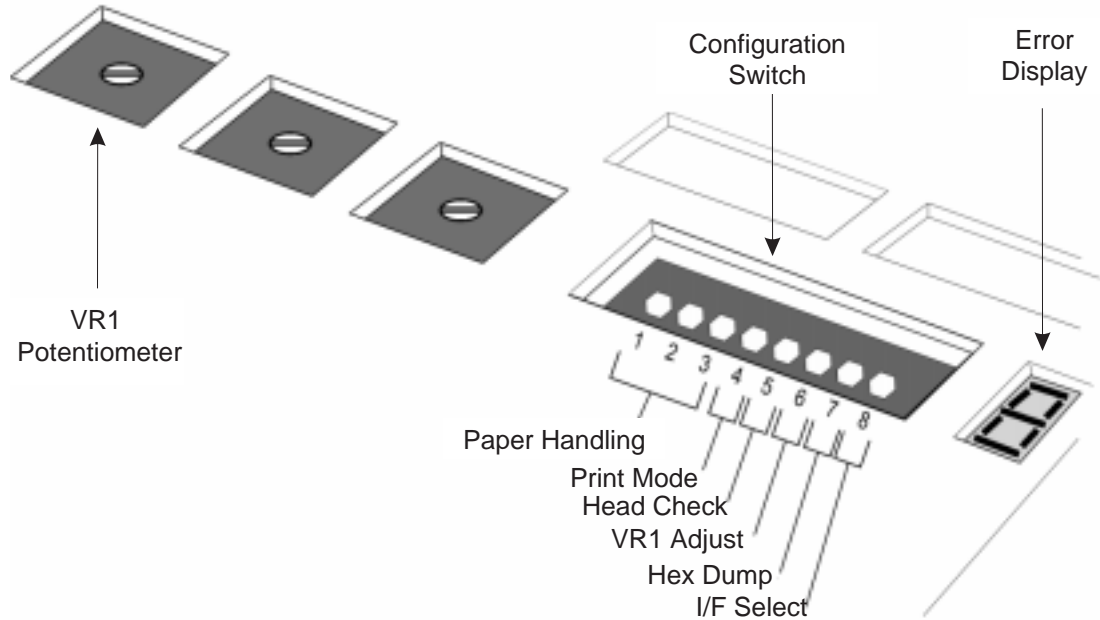

CONFIGURATION SWITCH

An eight position DIP switch is utilized for setting the operating conditions of the printer.

Paper Handling (DSW1-3). Selects the method used for controlling the paper handling.

Continuous - Does not use the sensor for paper indexing. The paper movement will stop after all the label data has been printed.

Tear Off - Paper is fed out to the cut/tear off position after printing is complete. Before the next label is printed, the paper is pulled back in to the first print line position.

Cutter Mode - Enables the Cutter option if installed.

Dispenser Mode - Enables the Label Taken sensor if the Dispenser option is installed.

DSW1	DSW2	DSW3	SETTING
Off	Off	Off	Continuous
On	Off	Off	Tear Off
Off	On	Off	Cutter Mode
On	On	Off	Dispenser

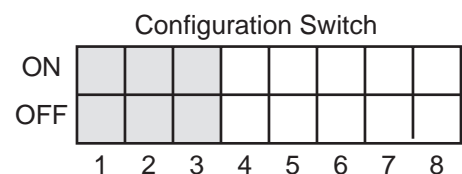

Font/Graphic Download (DSW1-3). Enables the downloading of fonts and/or graphics to printer memory.

DSW1	DSW2	DSW3	SETTING
Off	On	On	Enable

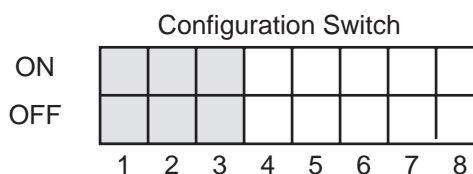

Print Method (DSW4). Selects Direct Thermal or Thermal Transfer print mode for a CT4XTT printer.

DSW4	SETTING
Off	Direct
On	Transfer

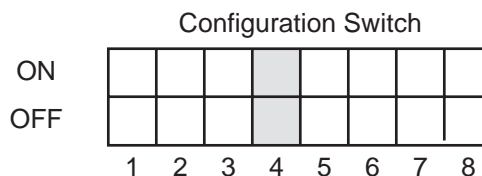

Head Check (DSW5). When selected, the printer will check for head elements that are electrically malfunctioning.

DSW5	SETTING
Off	Disabled
On	Enabled

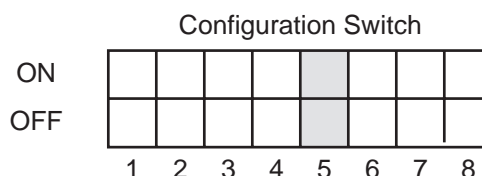

VR1 Potentiometer Function (DSW6). Select the function adjusted by VR1. When placed in the Off position, VR1 will adjust the pitch offset value over a range of +/- 3.75 mm. When placed in the On position, VR1 will adjust the print darkness range.

DSW6	SETTING
Off	Pitch
On	Darkness

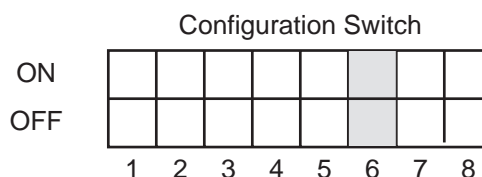

Hex Dump (DSW7). When ON, the printer will print out the hex value for each character received. When OFF, the printer will accept and process the data stream in a normal fashion.

DSW7	SETTING
Off	Normal
On	Hex

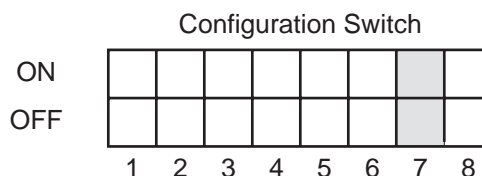

Section 2. Installation and Configuration

Interface Select (DSW8). When OFF, the printer will activate the Parallel input port for receiving data. When ON, the printer will activate the optional interface (if any) that is installed.

DSW8	SETTING
Off	Parallel I/F
On	Optional I/F

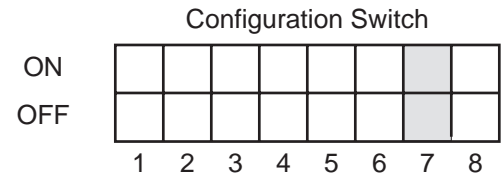

ERROR DISPLAY

The ERROR display is a seven segment LED array that provides information on error conditions detected by the printer. The conditions are:

LED	ERROR
0	Flash Memory error.
1	Not Assigned
2	Motherboard error
3	EEPROM error
4	Electrical Head error
5	Head not latched in the down position
6	Out of Paper
7	Sensor type or level error
8	Cutter error
8.	Program error
9	Ribbon End (TT mode only)
A	Receive buffer overflow
b	Parity error (Serial I/F only)
c	Framing error (Serial I/F only)
d	Overrun error (Serial I/F only)
E	Time Out error
F	Download Font/Graphic error

For more information the cause and troubleshooting of printer errors, see Section 6. Troubleshooting.

OFFSET

There are three offset settings stored in the printer; one for Dispense mode, one for the Cut mode and one for the Tear-Off mode. These three offsets can be set independently for each job using the <ESC>PO Pitch Offset command and will remain in the printer until a new command is received changing the setting or until power is turned off. The <ESC>PG Printer Setting command can be used to change the default settings of the printer. The default setting will always be active after power to the printer is cycled. The default settings can be determined by printing a User Test Label or displayed by the Printer Configuration Utility Program on the CD-ROM. Please note that the Printer Configuration Utility Program requires a bi-directional communications port on a host that is running Windows 9X.

The following should be used as starting points for establishing the three Offset values:

MODE	MILLIMETERS	INCHES	DOTS 203/305 dpi
CUTTER	17.9	0.70	143/215
DISPENSE	15.2	0.60	122/182
TEAR-OFF	29.2	1.15	234/350

POTENTIOMETER ADJUSTMENTS

PITCH OFFSET

After the Label Pitch Offset has been set using the <ESC>PO Pitch Offset command, it is sometimes desirable to make minor adjustments. This can be done using the VR1 potentiometer on the Configuration Panel. This potentiometer is set at the factory so that it has a range of +/-3.75 mm. The midpoint setting should have no effect on the label pitch. Turning the potentiometer all the way clockwise should move the print position 3.75 mm upwards towards the leading edge of the label. Turning it all the way counterclockwise should move the print position down 3.75mm away from the leading edge of the label.

- 1 Place DSW6 on the Configuration Switch in the OFF position.
2. Turn the Power Switch OFF.
3. While pressing the **FEED** key on the Operator Panel, turn the Power Switch ON.
4. When you hear one beep from the printer, release the **FEED** key .
5. Press the **LINE** key to begin printing large Test Labels (press the **FEED** key if you are using labels smaller than 4.1" (104 mm) in width).

Section 2. Installation and Configuration

- Adjust potentiometer **VR1** until the first print position is at the desired location on the label. If the potentiometer does not have enough range, you will have to change the Label Pitch setting using the <ESC>PO command.

Note: The printer will return to the default settings specified by the <ESC>PG command when power is cycled.

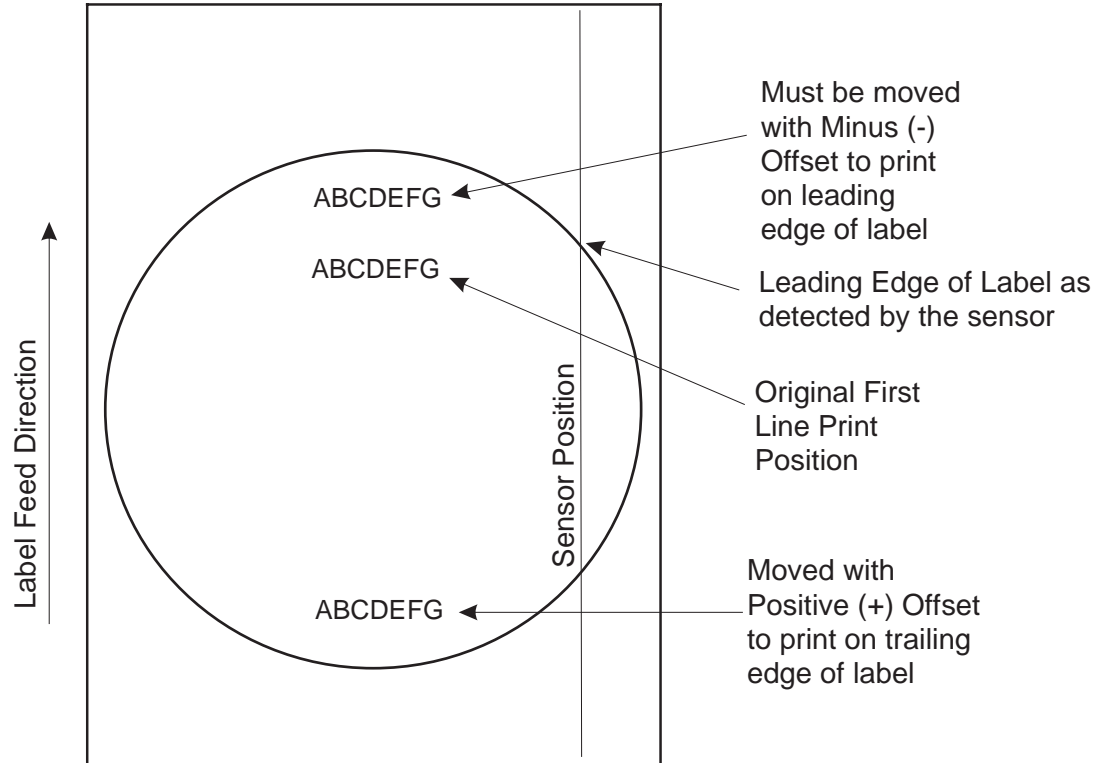

- Press the **FEED** key to stop the printing.

Note: Adjusting the Label Pitch with VR1 will affect the stop position of the label and the cut/dispense/tear-off positions.

Print Darkness

Print Darkness is set using the <ESC>#E Print Darkness command. A fine adjustment for PRINT DARKNESS can be made using potentiometer VR1 on the Front Operator Panel. It provides a continuous range of adjustment, allowing you to make precise changes. Turning **VR1** clockwise will make the print darker and counterclockwise will make it lighter.

1. Place DSW6 on the Configuration Switch in the ON position.
2. Turn the Power Switch OFF.
3. While pressing the **FEED** key on the Operator Panel, turn the Power Switch ON.
4. When you hear one beep from the printer, release the **FEED** key.
5. Press the **LINE** key to begin printing large Test Labels (press the **FEED** key if you are using labels smaller than 4.1" (104 mm) in width).
6. Adjust potentiometer **VR1** until the desired print darkness is obtained.
7. Press the **FEED** key to stop the printing.

Adjustment of the Print Darkness using VR1 will affect the darkness in all the <ESC>#E command code ranges, i.e., if the print darkness is adjusted with VR1 for lighter print, the darkness will be lighter in all the Print Darkness ranges selected by the command code.

HEX DUMP DIAGNOSTIC LABEL

The contents of the printer buffer can be examined using the Hex Dump mode. This printout labels each line of the received data in the left hand column, the data in hex format in the middle column followed by the same data in ASCII format in the right-hand column.

1. Turn the printer OFF.
2. Place DSW7 on the configuration Switch in the ON position.
3. Turn the printer ON.
4. Transmit data to the printer.
5. The data received is printed on the label.
6. Place DSW7 in the OFF position.
7. Turn the printer OFF and then back ON to place it back in the normal print mode.

```
00000000 1B411B4830303530 1B56303230301B42  E A H0050 V0200 B
00000010 443130343130302A 434C3430382A1B48 D104100*CL 408*H
00000020 303035301B563030 35301B4254303031 0050 V0050 BT001
00000030 3033303130331B42 5730333130303132 030103 BW0310012
00000040 333435360D0A1B51 311B5A0D0A      3456  L Q1  Z  L
```

PRINT TEST LABELS

USER TEST PRINT

The User Test Label prints the current default setting of the printer. These settings can be changed by sending new default settings with the <ESC>PG Printer Setting command.

1. Press the **FEED** key while simultaneously turning the **POWER** switch ON.
2. When the printer beeps, release the **FEED** key.
3. To print a large (4" wide) test label, press the **ON-LINE** key.
To print a small (2" wide) test label, press the **FEED** key.
4. The printer will continuously print the USER TEST LABEL until the **FEED** key is pressed. If the **FEED** key is pressed a second time, printing will resume.
5. To remove the printer from the Test Label mode, power the printer OFF.

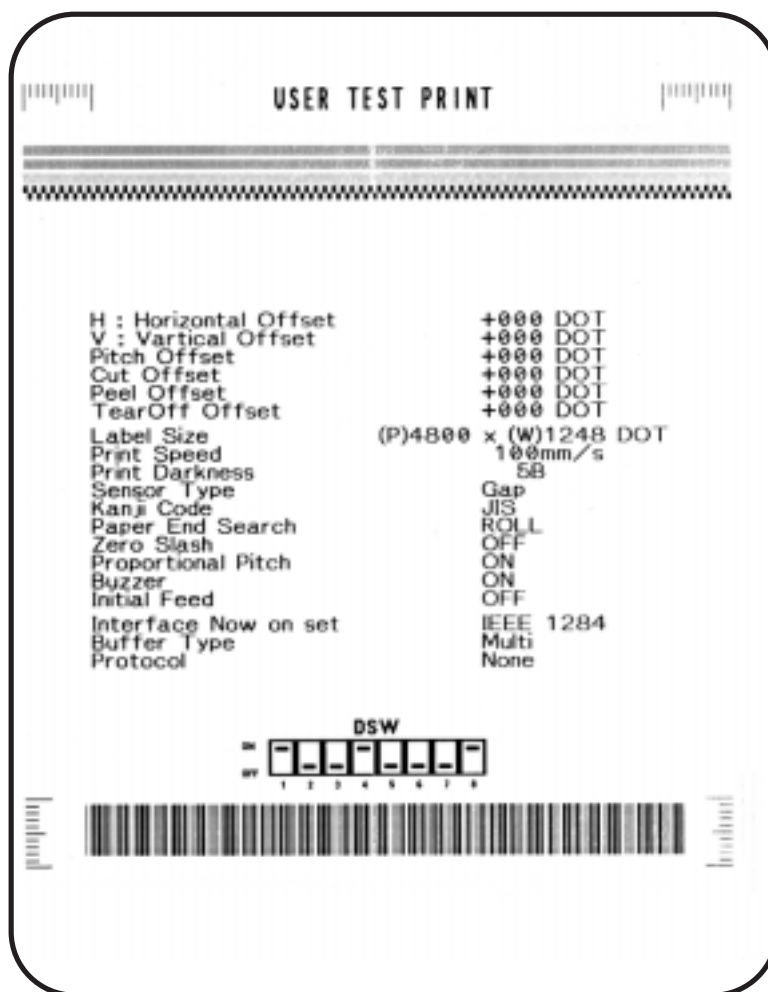

FACTORY/SERVICE TEST PRINT

The Factory/Service Test Label prints the internal operating parameters of the printer.

1. Open the print head by pushing the **Head Latch Lever** to the rear.
2. Press the **LINE** and **FEED** keys while simultaneously turning the **POWER** switch to the ON position.
3. When the printer beeps, release the **LINE** and **FEED** keys. The printer will then beep 3 times indicating it is in the Factory/Service Print Test mode.
4. Latch the Print Head in the down position.
5. Press the **LINE** key to print a large (4" wide") Factory/Service Test Label. Press the **FEED** key to print a small (2" wide) Factory/Service Test Label.
6. The printer will begin printing a series of test labels, the first containing the operational parameters of the printer followed by one containing the internal printer settings. these two label formats will alternate until the **FEED** key is pressed, suspending the print operation. If the **FEED** key is pressed again, the printing will resume.
7. To remove the printer from the Factory/Service Print Test mode, remove power by placing the **POWER** switch in the OFF position.

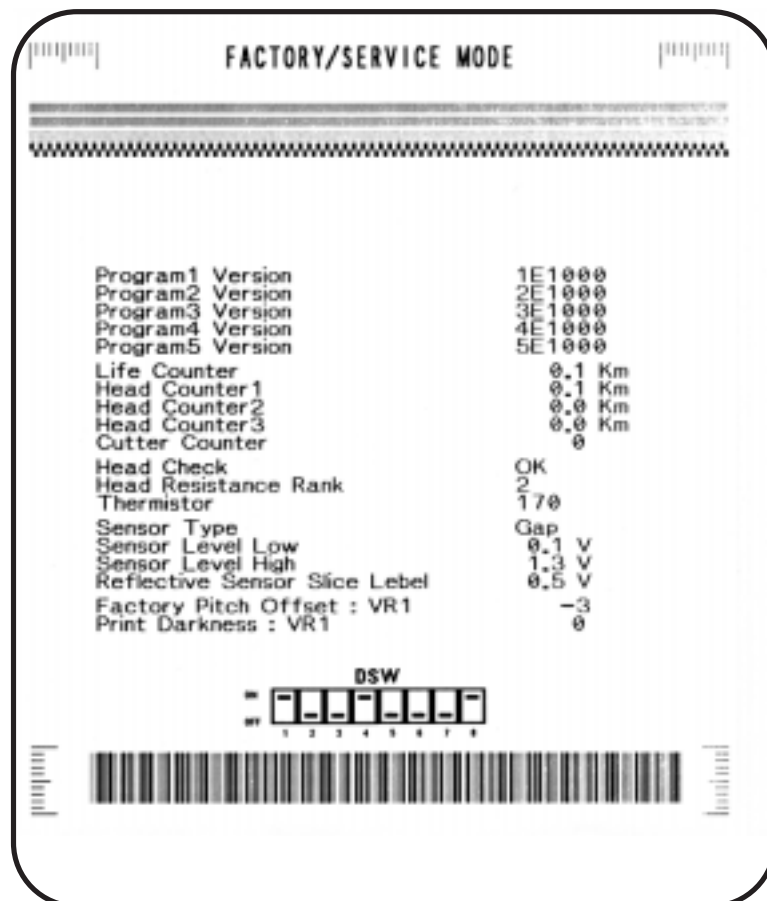

This page left intentionally blank.

SECTION 3.

CLEANING AND MAINTENANCE

INTRODUCTION

This section provides information on user maintenance for the CL Series printers. This section contains the following information.

- Adjusting the Print Quality
- Cleaning the Print Head, Platen and Rollers
- Replacing the Print Head
- Replacing the Fuse

PROCEDURES

ADJUSTING THE PRINT QUALITY

The CT400 and CT410 printers are equipped with two different methods of adjusting the quality of the print; print darkness and speed. When adjusting the printer for optimum print quality, a bar code verifier system should be used. The human eye is a poor judge of the relative widths of the bars in a symbol, a characteristic that is extremely important for good bar code quality.

Darkness (Print)

This adjustment allows the user to control (within a specified range) the amount of power that is used to activate the individual print head heat elements. It is important to find a proper print darkness level based on your particular label and ribbon combination. The printed images should not be too light nor should the ink from the ribbon “bleed.” The edges of each image should be crisp and well defined.

The print darkness level can be set by downloading the setting using the <ESC>#E Print Darkness software command (see Section 4, Programming Reference). There are five ranges 1 through 5, with the lightest setting being 1 and the darkest setting being 5. The <ESC>#E Print Darkness command also provides for darkness ranges matched to the type of media used. Setting “A” is used Direct thermal media and “B” for coated thermal transfer media.

Once the range has been selected, the **PRINT** Potentiometer on the front panel can be used to make finer adjustments.

Print

The fine adjustment for Print Darkness is the **VR1** potentiometer on the operator panel. It provides a continuous range of adjustment, allowing you to make precise changes. Use a small cross-point screwdriver, turning clockwise for darker print and counterclockwise for lighter print. See *Section 2: Installation and Configuration* for instructions on performing potentiometer adjustments

*NOTE: The **PRINT** potentiometer adjustment will affect the darkness in all of the command code speed ranges, i.e. if the **PRINT** potentiometer is adjusted for lighter print, the darkness will be lighter in all speed ranges selected by the command code.*

Print Speed

The other method of controlling print quality is by controlling the speed at which the label is printed. This adjustment is made only on an individual label basis using the <ESC>CSPrint Speed command code. For more details on this command, see *Section 4: Programming*. Changing the print speed allows the user to control the amount of time allowed for print element cooling before the media is stepped to the next print position. It is especially critical when printing “ladder” bar codes (bar codes printed with the bars parallel to the print line). When printing a “ladder” bar code, it is important to allow the head to cool sufficiently before stepping to the next position. If it does not have sufficient time to cool, the bar will be “smeared” on the trailing edge.

CLEANING THE PRINT HEAD, PLATEN AND ROLLERS

Supplies needed:

SATO SA070 Cleaning Kit

CLEANING THE PRINT HEAD

1. Turn the printer off and remove the power cable.
2. Open the **Top Cover**.
3. Open the **Print Head Assembly** by pushing the **Head Latch** toward the rear of the printer. The **Print Head Assembly** is spring-loaded and will automatically open as soon as the **Head Latch** is disengaged.
4. Rotate the **Print Head Assembly** upward to give access to the **Print Head**.
5. Remove the ribbon.
6. Apply **SATO Thermal Print Head Cleaner** to a cotton swab.
5. The **Print Head** faces downward along the front edge of the assembly. Pass the end of the dampened swab along the entire width of the **Print Head**.



5. Check for any black coloring or adhesive on the swab after cleaning.
6. Repeat if necessary until the swab is clean after it is passed over the head.
7. The head should be cleaned at least every time the ribbon is changed and more often in harsh environments.

CLEANING THE PLATEN AND PAPER ROLLER

1. Turn the printer off and remove the power cord.
2. Open the **Top Cover**.
3. Open the **Print Head Assembly** by pushing the **Head Latch** toward the rear of the printer. The **Print Head Assembly** is spring-loaded and will automatically open as soon as the **Head Latch** is disengaged. Rotate the **Print Head Assembly** upward to give access to the **Platen** and **Ribbon Roller**. Remove any labels in the printer.
4. Apply **SATO Thermal Print Head Cleaner** to one of the cotton swabs.
5. The **Platen** is the rubber roller directly below the **Print Head**. It should be cleaned of any ribbon or label residue. The **Platen** is easily cleaned by rotating the **Platen** with your thumb while cleaning the residue with the cotton swab.
6. The **Paper Roller** is located at the rear of the **Print Head Assembly**. It should be cleaned of any residue or foreign material.
7. Repeat if necessary. The platen and rollers should be cleaned whenever foreign matter such as dust or adhesive is present.



REPLACING THE PRINT HEAD

The print head on the CT printers is a user-replaceable item. If it becomes damaged for any reason, it can be easily removed and replaced. Contact your local SATO representative for information on obtaining a new print head.

Supplies needed: No. 2 Phillips screwdriver (a magnetic tip is helpful)

1. Turn the printer off and remove the power cable.
2. Open the **Top Cover**.
3. Open the **Print Head Assembly** by pushing the **Head Latch** toward the rear of the printer. The **Print Head Assembly** is spring-loaded and will automatically open as soon as the **Head Latch** is disengaged.
4. Remove the ribbon from the **Ribbon Spindle unit** if the printer is a thermal transfer version.

5. View the **Print Head Assembly** from the front of the printer. Locate the mounting screw on the top of the assembly. It is accessible through a hole in the top of the assembly. Unscrew these Head Retaining screw and set it aside.
6. The **Print Head** should now be loosened from the top of the assembly by grasping either side and carefully pulling it forward.
7. Disconnect the connecting cable from the print head connectors and set the **Print Head** aside.

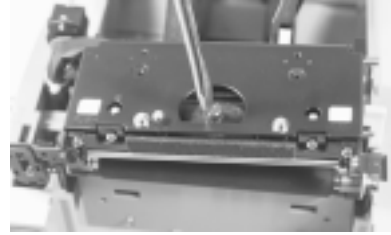

8. Carefully attach the new **Print Head** to the connectors, using caution to make sure the connector keys are correctly positioned. The connector is keyed so that it can only be inserted easily in the correct orientation.



NOTE: Be careful not to scratch the printing surface of the print head while installing it. Scratching the surface will cause permanent and irreparable damage and is not covered by the warranty!

9. Locate the mounting screw in the top plate assembly and align it with the tapped holes in the new **Print Head**.
10. Re-secure the print head by tightening the screw.



CLEANING THE SENSORS

There are two sensors that are used to control the positioning of the label. One is a transmissive see-thru sensor that detects the edge of the label by looking through the backing paper which is translucent and detecting the presence of the opaque label. The other is a reflective sensor that detects the light reflected from the bottom of the label liner. When a printed black Eye-Mark passes through the beam, the light is no longer reflected back to the sensor detector, indicating to the printer that it should use this position as the start of a new label. When dust, dirt or other foreign matter interferes with the light path of either of these sensors, the results is erratic label positioning. These sensors should be cleaned regularly, at least every two rolls of labels.

Supplies Needed:

SATO SA070 Cleaning Kit

1. Turn the printer off and remove the power cable.
2. Open the **Top Cover**.
3. Open the **Print Head Assembly** by pushing the **Head Latch** toward the rear of the printer. The **Print Head Assembly** is spring-loaded and will automatically open as soon as the **Head Latch** is disengaged. The sensors are built into the left hand **Label Guide** so that they move whenever the **Label Guides** are adjusted for different media widths.
4. Apply **SATO Thermal Print Head Cleaner** to one of the cotton swabs.
5. Use the cotton swab to clean any foreign matter from the exposed surface of the sensors by inserting the cotton tip in the paper slot and briskly cleaning it with a back and forth motion.



This page left intentionally blank.

SECTION 4. PROGRAMMING

INTRODUCTION

This section presents the commands that are used with the SATO CT Series printers to produce labels with logos, bar codes and alphanumeric data. All of the CT commands use the same syntax. Some commands reference a physical point on the label using horizontal and vertical dot reference numbers. The allowable range for these references is dependent upon the particular printer to accommodate different print widths and resolutions. These differences are noted in tables under the commands affected.

The following information is presented in this section:

- The SATO Programming Language
- Protocol Control Codes
- Using Basic
- The Print Area
- Command Codes

THE SATO CT PROGRAMMING LANGUAGE

A programming language for a printer is a familiar concept to most programmers. It is a group of commands that are designed to use the internal intelligence of the printer. The commands, which are referred to as CT Command Codes, contain non-printable ASCII characters (such as <STX>, <ETX>, <ESC>) and printable characters. These commands must be assembled into an organized block of code to be sent as one data stream to the printer, which in turn interprets the command codes and generates the desired label output. The programmer is free to use any programming language available to send the desired data to the SATO CT Series printer.

The command codes used by the SATO CT Series Printers are based upon “Escape” (1B hexadecimal) sequences. Typically there are four types of command sequences:

<ESC>{Command}

These commands generally tell the printer to perform a specific action, like “clear the memory.”

<ESC>{Command} {Data}

Commands with this format tell the printer to perform a specific action which is dependent upon the following data, like “print X labels”, where the value for X is contained in the data.

<ESC>{Command} {Parameter}

These commands set the operational parameters of the printer, like “set the print speed to 3.”

<ESC> {Command} {Parameter} {Data}

Some commands can contain both Parameter and Data elements, such as “print a Code 39 symbol containing the data”.

PROTOCOL CONTROL CODES

Protocol codes are the special control characters that prepare the printer to receive instructions. For example, the <ESC> character tells the printer that a command code will follow and the <ENQ> character asks for the printer status.

There are two pre-defined different sets of Protocol Control codes to choose from. Each set is made up of six special characters. The Standard Protocol Control codes are non-printable characters, and the Non-Standard Protocol Control codes are printable characters. The Non-Standard set may be useful on host computers using protocol converters or in an application where non-printable ASCII characters cannot be sent from the host. This manual uses the Standard Protocol Control codes for all of the examples.

CONTROL CHARACTER	HEX VALUE	DESCRIPTION
SOH	01	Status Request
STX	02	Start of Data
ETX	03	End of Data
ESC	1B	Command code to follow
NULL ~	00 7E	Cutter command (Responds to either)
ENQ	05	Get printer status, Bi-Com Mode
CAN	18	Cancel Print Job
DLE	10	Print Stop
DC1	11	Print Start
Off-Line	40 Hex	Take printer Off-Line

USING BASIC

It may be useful to test your CT printer using a BASIC program on a PC. You may also write your actual production programs in BASIC. Whatever the reason, if you will be working in BASIC, some of the following hints may help you get started:

1. Set the WIDTH of the output device to 255 characters to avoid automatically sending <CR> and <LF> characters after every line. The command string should be continuous and uninterrupted by <CR> and/or <LF> commands. The examples given in this manual are printed on separate lines because they will not fit on one line and do not contain any <CR> and/or <LF> characters. If these characters are needed, they are explicitly noted by the inclusion of <CR> and <LF> notations.

- If you are using the printer's RS232 interface, it is necessary to set the COM port on the PC such that the CTS and DSR signals will be ignored. Send your OPEN "COM" statement in the following way:

```
OPEN "COM1:9600,E,8,1,CS,DS" AS #1
```

This sets the RS232 communication parameters of the host PC's COM1 port for 9600 baud, Even parity, 8 Data bits, 1 Stop bit and directing the port to ignore the **CTS** and **DSR** control signals.

- You may want to minimize keystrokes and program size by assigning the **<ESC>** character to a string variable since this character is used quite often.

The following two examples in BASIC show a typical example using these hints. Both of these examples use the Standard Protocol codes.

Printing with the Parallel Port

5	REM CT410 Parallel Example	Identifies the program as a CT410 parallel port print label. The "REM" prevents this data from being sent to the printer and displays it only on the screen.
10	E\$=CHR\$(27);	Sets the "E\$" string as an <ESC> character
20	WIDTH "LPT1:",255;	Sets the width of the output to 255 characters
30	LPRINT E\$;"A";	Sends an "<ESC>A" command code to the LPT1 parallel port
40	LPRINT E\$;"H400";E\$;"V100";E\$;"XL1SATO";	Sends the data "SATO" to be placed 400 dots horizontally and 100 dots vertically on the label and printed in the "XL" font.
50	LPRINT E\$;"Q1";	Instructs the printer to print one label.
60	LPRINT E\$;"Z";	Tells the printer that the last command has been sent. The printer can now create and print the job.

Printing with the RS232 Port

5	REM CT410 RS232 Example	Identifies the program as a CT410 RS232 port print label. The "REM" prevents this data from being sent to the printer and displays it only on the screen.
10	E\$=CHR\$(27);	Sets the "E\$" string as an <ESC> character.
20	OPEN "COM1:9600,N,8,1,CS,DS" AS #1;	Opens the COM1 port for output and sets the parameters as 9600 baud, No parity, 8 Data bits, 1 Stop bit and instructs the port to ignore the CTS and DSR control signals.

30 PRINT #1,CHR\$(2);	Sends an <STX> (ASCII Code decimal "2") to the printer instructing it to prepare to receive a message.
50 PRINT #1,E\$;"A";	Sends an "<ESC>A" command code to Print Port #1 opened by statement 20 above.
60 PRINT #1, E\$;"H400";E\$;"V100";E\$;"XL1SATO";	Sends the data "SATO" to be placed 400 dots horizontally and 100 dots vertically on the label and printed in the "XL" autosmoothed font.
50 PRINT #1, E\$;"Q1";	Instructs the printer to print a quantity of one label.
60 PRINT #1, E\$; "Z";	Tells the printer that the last command has been sent. The printer can now create and print the job.
70 PRINT #1,CHR\$(3);	Sends an <ETX> (ASCII Code decimal "3") to the printer telling it that this is the end of the message.

THE PRINT AREA

The maximum print area for the various CT Series printers is listed in Table 4.1, Print Area. Most of your label applications will not require labels that fill the entire print area. To make label design simpler, the media on the CT Series printers is center justified, i.e. the label is always centered on the print head. An <ESC>A1 Media Size command is then used to specify the length and width of the label. The CT printer uses this information to automatically calculate an "offset" that will move the Horizontal Reference point to coincide with the first printable dot position on the specified label. It is extremely important to use the Media Size command. If you do not, you will have to manually calculate the offset and send it to the printer using the <ESC>A3 Base Reference Point command.

The diagram below illustrates the maximum print area and a sample 2 inch wide by 3 inch long label placed within this area. As can be seen, your label will be oriented in the middle of the print head as viewed from the front of the printer. The normal

Table 4.1, Print Area

	CT400	CT410
Resolution	203 dpi 8 dpmm	305 dpi 12 dpmm
Max Print Width	832 dots 4.1 in. 104 mm	1248 dots 4.1 in. 104 mm
Max Label Width	4.5 in. 115 mm	4.5 in. 115 mm
Print Length	3200 dots 15.7 in. 400 mm	4800 dots 15.7 in. 400 mm

reference point is located at the H1, V1 position of the print area in the normal print orientation (no rotation).

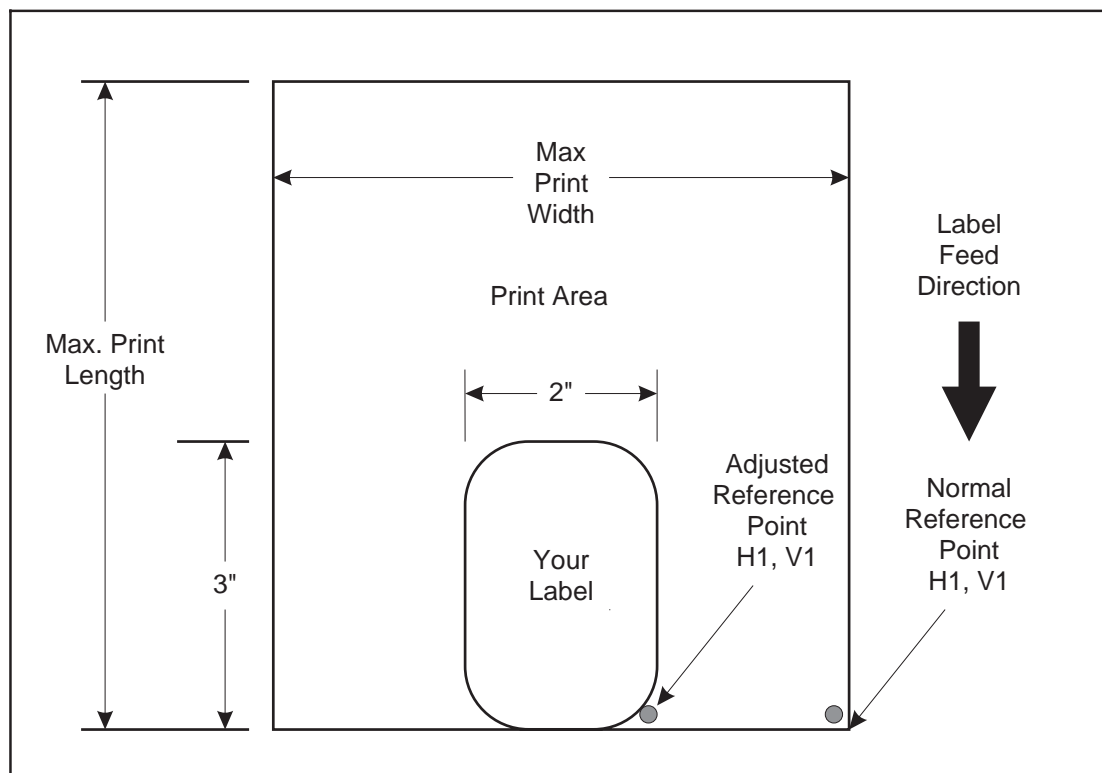

ROTATED FIELDS

The CT Series printers can rotate each print field in 90° increments using the <ESC>% Rotate command.

The following data stream will rotate the print field but will not change the base reference point of the field:

```
<ESC>A<ESC>%1<ESC>V800<ESC>H200<ESC>L0202<ESC>XB1E<ESC>Q1<ESC>Z
```

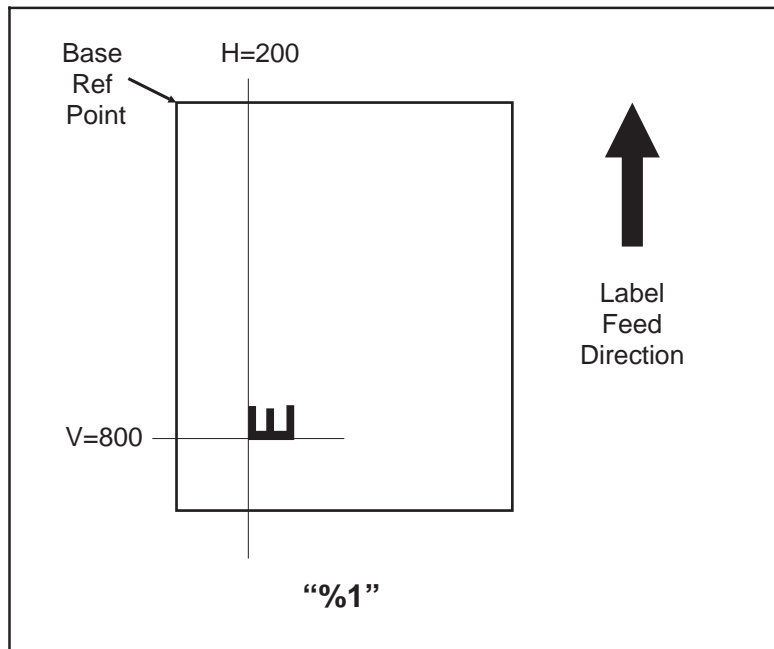

COMMAND DEFAULT SETTINGS

There are some types of commands that must have a value specified before a label can be printed. If the data stream does not contain these commands, a “default” value is assumed. The default settings are determined by the values specified in the last <ESC>PG Printer Setting command sent to the printer. These values are stored in EEPROM and will remain valid even if power to the printer is cycled.

COMMAND CODES

This section contains all the CT Series printer Command Codes. The commands must be sent to the printer in an organized fashion in order for the label(s) to print.

The purpose of this section is to:

1. Explain the different commands and provide examples of their usage.
2. To provide a detailed reference for programming the CT Series Printers.

Each command begins on a separate page with its own heading. A uniform layout is used to help you find key information about each command. For each Command

Code in this section, there will be a sample data input stream to the printer and the expected print output. By studying the examples, you can learn how to use the particular command within a whole block of printer code. Pay particular attention to the “Special Notes” with each command to learn other important information.

The subject commands are highlighted in bold letters in the Reference Sheets. There are two parts of most, but not all, commands. The first is the command character which immediately follows the <ESC> code. It is always an upper case alpha or a special character (such as an “&” or a “%”). It is never a lower case alpha character. If the command requires additional variable information, it is represented by a group of lower case alpha characters immediately following the command character. For example, if an **aaaabb** is listed following the basic command, the printer will look for six characters immediately following the command. The first four would represent the value of **aaaa** and the next two the value of **bb**.

The maximum number of characters defined in a parameter is represented by the number of characters shown in the command structure. For example, a command followed by an **aaaa** can have up to four characters. In general, commands with only one parameter following the command can be entered without the leading zeroes. However, certain commands require the exact number of matching characters. A command with two parameters listed following the command code without a comma delimiter, such as **aaaabbbb** require the exact number of digits to be entered. If the value of **aaaa** is “800” and the value of **bbbb** is “300”, then the parameters must be entered as “08000300”. It is recommended that you make it a practice to always enter leading zeros to prevent any mistakes.

NOTE: These examples assume the use of the Standard Protocol Command Codes, a parallel interface and a 4 inch wide label in a CT400 printer. The labels for all other printers will be similar, but, because of different resolutions and print widths may be larger or scaled differently.

An alphabetical listing of the command codes is contained in Appendix A: Command Code Quick Reference.

This page left intentionally blank.

Bar Codes

Command Structure 1:3 narrow/wide bar ratio: <ESC>**Babbcccd**
 2:5 narrow/wide ratio: <ESC>**BDabbcccd**
 1:2 narrow/wide bar ratio: <ESC>**Dabbcccd**

- a = Bar Code Symbol
- 0 Codabar
 - 1 Code 39
 - 2 Interleaved 2 of 5 (I 2/5)
 - 3 UPC-A / EAN-13
 - 4 EAN-8
 - 5 Industrial 2 of 5
 - 6 Matrix 2 of 5
 - 7 reserved
 - 8 reserved
 - 9 reserved
 - A MSI
 - B reserved
 - C Code 93
 - D reserved
 - E UPC-E
 - F Bookland
 - G Code 128
 - I UCC 128
- bb = Number of dots (01-12) for narrow bar and narrow space
- ccc = Bar height in dots (001-600)
- d = UCC 128 only. Not used for other bar code types
- 0 No human readable text
 - 1 Human readable at top
 - 2 Human readable at bottom

Example: <ESC>**BD103200**

Placement: Immediately preceding data to be encoded

Default: None

Command Function To print bar code images on a label. With this command, there are 13 standard bar code symbologies available to be printed and three two dimensional symbols (see Two Dimensional Bar Code Symbols at the end of this section). Each of the bar codes are unique, and it is important to know the differences. See Appendix B for specific information on using each individual bar code symbol.

Input to Printer

<ESC>A

<ESC>H050<ESC>V0025<ESC>B103100*CODE 39*
<ESC>H0230<ESC>V0130<ESC>XS*CODE 39*

<ESC>H050<ESC>V0175<ESC>BD20310045676567
<ESC>H0215<ESC>V0285<ESC>XM45676567

<ESC>H050<ESC>V0325<ESC>BD30215001234567890
<ESC>H050<ESC>V0525<ESC>BD50310012345
<ESC>H0250<ESC>V0635<ESC>XS12345

<ESC>H050<ESC>V0675<ESC>BD60310012345
<ESC>H0230<ESC>V0785<ESC>XS12345

<ESC>H050<ESC>V0825<ESC>BA03100123455
<ESC>H0170<ESC>V935<ESC>XS12345

<ESC>H050<ESC>V980<ESC>BC03100081234ABCD
<ESC>H0155<ESC>V1095<ESC>XS1234ABCD

<ESC>H050<ESC>V1130<ESC>B002100A12345B
<ESC>H090<ESC>V1240<ESC>XS12345

<ESC>H0530<ESC>V0025<ESC>BD303100123456789012

<ESC>H0590<ESC>V0525<ESC>BD4031001234567

<ESC>H0575<ESC>V175<ESC>DE03100123456
<ESC>H0550<ESC>V0225<ESC>OB0
<ESC>H0583<ESC>V0280<ESC>OB123456

<ESC>H0325<ESC>V0325<ESC>D30315009827721123

<ESC>L0101<ESC>H0295<ESC>V0400<ESC>OB0
<ESC>H0340<ESC>V0478<ESC>OB98277
<ESC>H 0480<ESC>V0478<ESC>OB21123

<ESC>H630<ESC>V0365<ESC>BF0313021826
<ESC>H645<ESC>V0335<ESC>OB21826

<ESC>H0450<ESC>V0675<ESC>D30315000633895260
<ESC>L0101<ESC>H0415<ESC>V0750<ESC>OB0
<ESC>H0465<ESC>V0828<ESC>OB06338
<ESC>H 0605<ESC>V0828<ESC>OB95260

<ESC>H0755<ESC>V0705<ESC>BF0314024
<ESC>H0770<ESC>V0675<ESC>OB24

<ESC>H0450<ESC>V0980<ESC>BG03100>GAB>B789>C123456
<ESC>H0560<ESC>V1085<ESC>XS AB789123456

<ESC>Q1<ESC>Z

Note: Carriage Returns and Line Feeds have been added to the command listing for clarity and should not be included in the actual data stream.

Printer Output



UCC-128

Without Incrementing

```
<ESC>A  
<ESC>H0100<ESC>V0100<ESC>BI07150101234567000000001  
<ESC>Q2<ESC>Z
```



With Incrementing

```
<ESC>A  
<ESC>H0100<ESC>V0100<ESC>F001+001<ESC>BI07150101234567000000001  
<ESC>Q2<ESC>Z
```



Special Notes

1. UPC and EAN bar codes are not affected by the different types of narrow to wide ratios. Instead, the <ESC>D command adds descender bars to these codes where needed to meet UPC specifications. The <ESC>BD command puts descender bars and human readable text below the symbol.
2. The Code 128, UCC 128, MSI, and Code 93 bar codes are not affected by the narrow to wide ratios.
3. The Codabar, Code 39, Industrial 2 of 5, and Matrix 2 of 5 bar codes are affected by the Character Pitch command. This command must be placed before the Bar Code command.
4. See Appendix B for more specific instructions and detailed information regarding individual bar code symbols.
5. Because of their unique characteristics, two-dimensional symbols are covered separately.
6. For UCC128, the FNC1 code is automatically inserted and the Mod 10 and Mod 103 check digits are automatically calculated.
7. The <ESC>D and <ESC>BD commands are not valid for the MSI, Code 128, Code 93, UPC-E, Bookland, UCC128 and Postnet symbologies.

Bar Codes, Expansion

Command Structure <ESC>**BW**aa**bbb**

aa = Expansion factor by which the width of all bars and spaces will be increased (01-12)

bbb = Bar height by dot (004-600 dots)

Example: <ESC>**BW02100**

Placement: Immediately follows the <ESC>BT command and precedes data to be encoded.

Default: None

Command Function This command works together with the <ESC>BT command to specify an expansion factor and the bar code height for the particular symbol being printed.

Input to Printer: <ESC>A
<ESC>H0050<ESC>V0200<ESC>BD103100*SATO*
<ESC>H0050<ESC>V0050<ESC>BT001030103<ESC>**BW03100123456**
<ESC>Q1<ESC>Z

Printer Output:

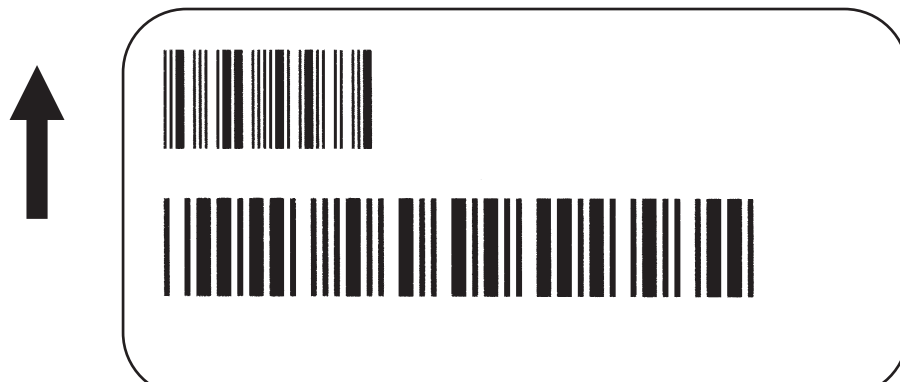

- Special Notes**
1. This command must be preceded by the Variable Ratio Bar Codes <ESC>BT command.
 2. The following bar codes will be affected by the Character Pitch command: Codabar, Code 39, Interleaved 2 of 5, Matrix 2 of 5.

Bar Codes, Variable Ratio

Command Structure <ESC>**BT**abbccddee

a = Bar Code Symbol:
 0 Codabar
 1 Code 39
 2 Interleaved 2 of 5
 5 Industrial 2 of 5
 6 Matrix 2 of 5

bb = Narrow space in dots (01-99)
 cc = Wide space in dots (01-99)
 dd = Narrow bar in dots (01-99)
 ee = Wide bar in dots (01-99)

Example: <ESC>**BT**101030103

Placement: Following print position commands and preceding
 <ESC>BW

Default: Current setting

Command Function To print a bar code with a ratio other than those specified through the standard bar code commands (B,BD, and D). This is done through individual control of each of the bar code elements (bars, spaces) as shown above. Remember that this command only applies to the five bar code types shown.

Input to Printer:

```
<ESC>A
<ESC>H0050<ESC>V0200<ESC>BD104100*SATO*
<ESC>H0050<ESC>V0050<ESC>BT001030103<ESC>BW03100123456
<ESC>Q1<ESC>Z
```

Printer Output:

Special Notes

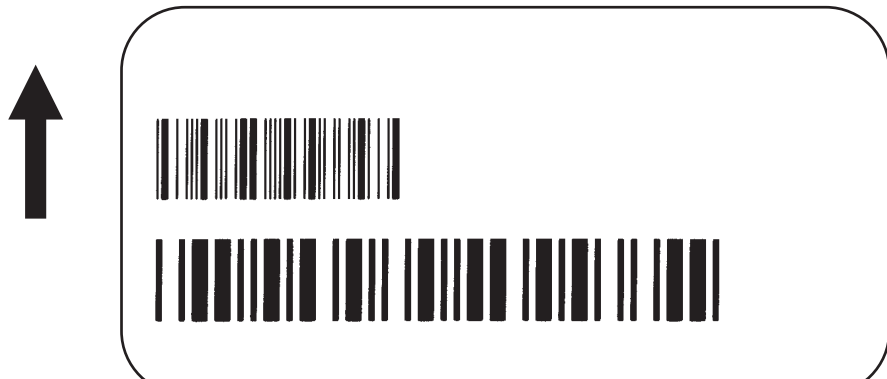

1. This command must be immediately followed by the <ESC>BW Bar Code Expansion command.
2. You may use only one variable ratio bar code per label.
3. If the data specified in this command is incorrect, the command is ignored and the ratio used will be based on the previous setting.
4. See Appendix B for more specific instructions and details regarding individual bar code symbols.

Base Reference Point

Command Structure <ESC>**A3HabbbbVcdddd**

- a = - Specifie that the horizontal offset is in the negative direction.
 + Specifies that the horizontal offset is in the positive direction.
- bbbb = Horizontal Print Offset (see Note 5 for field range)
- c = - Specifie that the vertical offset is in the negative direction.
 + Specifies that the vertical offset is in the positive direction.
- dddd = Vertical Print Offset (see Note 5 for field range)

Example: <ESC>**A3H+100V+0050**

Placement: Preceding all images that are based on the new base reference point

Default: Current V and H offset setting in the printer configuration

Command Function To establish a new base reference point for the current label. The base reference point is the top left corner or "origin" from where all print position commands are based.

This command may be very helpful when using labels less than four inches wide to place images on the printable label surface. It may also be used to move images past preprinted fields on a label.

Input to Printer:

```
<ESC>A<ESC>L0202
<ESC>H0100<ESC>V0025<ESC>XMNORMAL REFERENCE POINT
<ESC>A3H+0300V+0075
<ESC>H0100<ESC>V0050<ESC>XMNEW REFERENCE POINT
<ESC>Q1<ESC>Z
```

Printer Output:

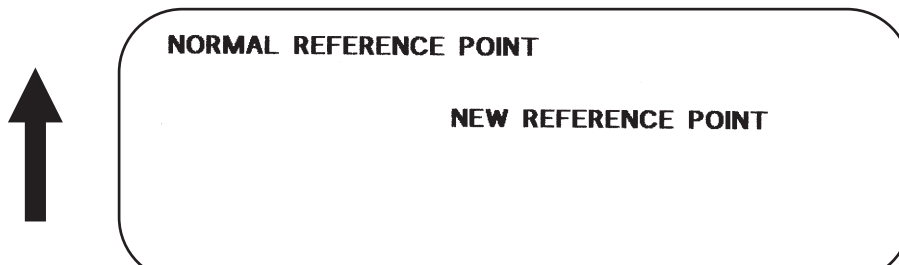

Special Notes

1. Use of this command will set the Vertical/Horizontal Offset setting of the printer configuration until a new Base Reference Point command is issued or the setting is changed from the operator panel. See Section 2: Printer Configuration.
2. This command may be used more than once in a print job.
3. An alternative to using this command is to make changes to your current Horizontal and Vertical Print Position commands.

Example:

Let's say the current base reference point is H=1, V=1 and you wish to move all the fields on your label downward vertically by 150 dots. You could either (1) add the Base Reference Point command or (2) change all the vertical position commands by an additional 150 dots.

4. For a more detailed example of the Base Reference Point command, see "Print Area" in this section.
5. The allowable field ranges for this command are:

	CT400	CT410
Horizontal aaaa	-0832 to 0832	-1248 to 1248
Vertical bbbb	-3200 to 3200	-4800 to 4800

Characters, Custom-Designed

Command Structure	<p>Store Command: <ESC>Tabcc Recall Command: <ESC>Kab90cc</p> <p>a = 1 16x16 matrix 2 24x24 matrix</p> <p>b = Specifies the character encoding method for the data stream H Hexadecimal characters B Binary characters</p> <p>cc = Memory location to store/recall the character. Valid memory locations are 21 to 52 (counting in Hex) or “!” to “R” in Binary</p> <p>(data) = Data to describe the character</p> <p>Example: <ESC>T1H3F <ESC>K1H903F See Appendix C for a more detailed explanation</p> <p>Placement: The Store command is typically sent in its own data stream to the printer, between the Start/Stop commands. The Recall command is sent in a secondary data stream to print the character, and follows any necessary position or size commands.</p> <p>Default: None</p>
Command Function	To allow for the creation, storage, and printing of custom characters, such as special fonts or logos. Up to 50 individual characters may be stored in the custom character volatile memory.
Printer Input	See Appendix C for a detailed explanation.

```
<ESC>A
<ESC>T1H3F
0100038007C00FE01FF03FF87FFCFFFE07C007C007C007C007C007C007C0
<ESC>Z
```

```
<ESC>A
<ESC>H150<ESC>V100<ESC>L0505<ESC>K1H903F
<ESC>H350<ESC>V100<ESC>L1010<ESC>K1H903F
<ESC>Q1<ESC>Z
```

Printer Output

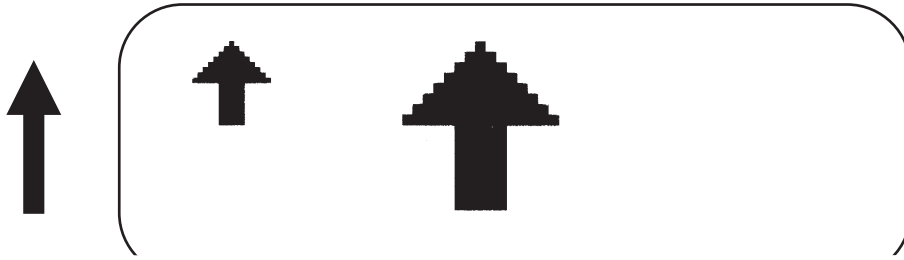

Special Notes

1. When printing the custom character using the Recall command, the character is affected by the following commands:

- Character Expansion
- Character Pitch
- Line Feed
- Rotate, Base Reference Point Fixed
- Rotate, Moving Base Reference Point

2. The characters are stored in volatile memory and must be reloaded if the printer power is lost.
3. Do not use ASCII <CR> or <LF> characters (carriage return or line feed) as line delimiters within the graphic data or the actual image will not be printed as specified.

Character Expansion

Command Structure <ESC>Laabb

aa = Multiple to expand horizontally (01-12)
bb = Multiple to expand vertically (01-12)

Example: <ESC>L0305

Placement: Preceding the data to be expanded

Default: <ESC>L0101

Command Function

To expand characters independently in both the horizontal and vertical directions. The command allows you to enlarge the base size of each font (except the vector font) up to 12 times in either direction. Expanded characters are typically used for added emphasis or for long distance readability.

Input to Printer

```
<ESC>A
<ESC>A<ESC>H0100<ESC>V0100<ESC>XMSATO
<ESC>H0100<ESC>V0200<ESC>L0402<ESC>XMSATO
<ESC>H0100<ESC>V0300<ESC>L0204<ESC>XMSATO
<ESC>Q1<ESC>Z
```

Printer Output



Special Notes

This command will expand the following fonts:

1. Fonts U, S, M, XU, XS, XM, OA & OB and fonts WB, WL, XB and XL.
2. This command will also affect the following commands:
Character Pitch
Characters, Custom-Designed
3. The Character Expansion value is in effect for the current print job until a new expansion command is specified.
4. The Line and Box command, if used within the data stream, may return all subsequent text to the default expansion of 1 x 1. Therefore, either send the Character Expansion command before all printed data, or send Line and Box commands last, preceding the <ESC>Q Quantity command.

Character, Fixed Spacing

Command Structure <ESC>PR

Example: See Above

Placement: Preceding the data

Default: The default is Proportional Spacing.

Command Function To reset proportional spacing and place the printer back to fixed spacing

Printer Input

```
<ESC>A
<ESC>H0025<ESC>V0050<ESC>PS
<ESC>L0202<ESC>XMPROPORTIONAL SPACING
<ESC>H0025<ESC>V0130<ESC>PR
<ESC>L0202<ESC>XMFIXED SPACING
<ESC>Q1<ESC>Z
```

Printer Output



Special Notes

1. This command only works with the proportionally spaced fonts XU, XM, XS, XL and XB.

Character Pitch

Command Structure <ESC>Paa

aa = Number of dots between characters (00-99)

Example: <ESC>P03

Placement: Preceding the text to be printed

Default: <ESC>P02

Command Function To designate the amount of spacing (in dots) between characters. This command provides a means of altering character spacing for label constraints or to enhance readability.

Input to Printer <ESC>A<ESC>PS
<ESC>H0025<ESC>V0025<ESC>L0202<ESC>XBSATO
<ESC>H0025<ESC>V0125<ESC>L0202<ESC>P20<ESC>XB1SATO
<ESC>H0025<ESC>V0225<ESC>L0202<ESC>P40<ESC>XB1SATO
<ESC>Q1<ESC>Z

Printer Output



Special Notes

1. This command is affected by the <ESC>L Character Expansion command. The character pitch is actually the product of the current horizontal expansion multiple and the designated pitch value.

Example:

<ESC>L0304

<ESC>P03

Pitch = (03) x (03) = 9 dots

2. To avoid confusion, you may want to include the <ESC>L Character Expansion command and this command together in your program.
3. This command affects fonts U, S, M, XU, XS, XM, OA & OB, fonts WB, WL, XB and XL, and the vector font.
4. Character Pitch will always revert to the default value unless it is specified before each new font command in the data stream.
5. This command also affects Codabar, Code 39 and Industrial 2 of 5 bar codes.

Character, Proportional Spacing

Command Structure <ESC>PS Set to proportional spacing
 <ESC>PR Reset to fixed spacing

Example: See above

Placement: Preceding the data to be proportional spaced

Default: <ESC>PS

Command Function To specify the printing of proportional or fixed spacing for proportionally spaced fonts.

Printer Input

```
<ESC>A  
<ESC>H0025<ESC>V0050<ESC>PS  
<ESC>L0202<ESC>XMPROPORTIONAL SPACING  
<ESC>H0025<ESC>V0130<ESC>PR  
<ESC>L0202<ESC>XMFIXED SPACING  
<ESC>Q1<ESC>Z
```

Printer Output



Special Notes

1. Once this command is sent in the data stream, it is in effect until the end of the print job unless a reset command is sent.

Clear Print Job(s) & Memory

Command Structure	<ESC>*a
	<p>a = If the “a” parameter is not included with this command and the printer is in the multi-buffer mode, this command clears all print jobs in the printer memory, including the current print job.</p> <p>a = If “a” is included with this command, it specifies the internal memory section to be cleared</p> <p>T To clear the custom character memory</p> <p>& To clear the form overlay memory</p> <p>X To clear all internal memory</p>
	<p>Example: <ESC>* <ESC>*X</p>
	<p>Placement: This command should be sent to the printer as an independent data stream.</p>
	<p>Default: None</p>
Command Function	To clear individual memory or buffer areas of the printer.
Input to Printer	<ESC>A <ESC>* <ESC>Z
Printer Output	There is no printer output as a result of this command. The current print job in the buffer will be terminated and all other print jobs in the buffer cleared.
Special Note	<ol style="list-style-type: none"> 1. It is not necessary to clear the printer’s memory between each print job. 2. The primary purpose of this command is to clear all print jobs in the multi-buffer mode. The “a” parameter can be used in either the multi-buffer or single job mode to clear specific parts of the memory. 3. When the “a” parameter is used, the section of memory specified will not be cleared until the label is printed.

Continuous Forms Printing

Command Structure None

The printer locates the end of an adhesive label by sensing the backing between labels or through the use of an eye-mark (black rectangle on the reverse side of the backing). It locates the end of a tag from a notch, eye-mark, or a hole between tags. Both sensors should be disabled when printing continuous forms. See Configuration Commands at the end of this section for information on using the <ESC>IG Sensor Select command. To change the default setting to Continuous Forms Printing, use the <ESC>PG Printer Setting command.

If you will be using continuous labels or tags, the printer must be told to stop feeding in another manner. The length is determined by the position of the last printed image on the label or tag. The printer will stop feeding when this last field is finished printing. The length may be increased with printed spaces (20 hexadecimal) if necessary. There is no command code to control label length.

Copy Image Area

Command Structure <ESC>**WDH**aaaa**V**bbbb**X**cccc**Y**dddd

aaaa = Horizontal position of the top left corner of the area to be copied

bbbb = Vertical position of the top left corner of the area to be copied

cccc = Horizontal length of the image area to be copied

dddd = Vertical length of the image area to be copied

Example: <ESC>**WDH0100V0050X0600Y0400**

Placement: Anywhere within the data stream, after specifying the location of the duplicate image.

Default: None

Command Function To copy an image from one location to another on the same label. This may be useful for duplicating individual fields or entire sections of the label with only one command.

Input to Printer

```
<ESC>A
<ESC>H0050<ESC>V0050<ESC>E010<ESC>XM
SATOROSATOROSATOROSATO
SATOROSATOROSATOROSATO
SATOROSATOROSATOROSATO
SATOROSATOROSATOROSATO
SATOROSATOROSATOROSATO
<ESC>H0180<ESC>V0250<ESC>WDH0165V0050X0400Y0200
<ESC>Q1<ESC>Z
```

Printer Output

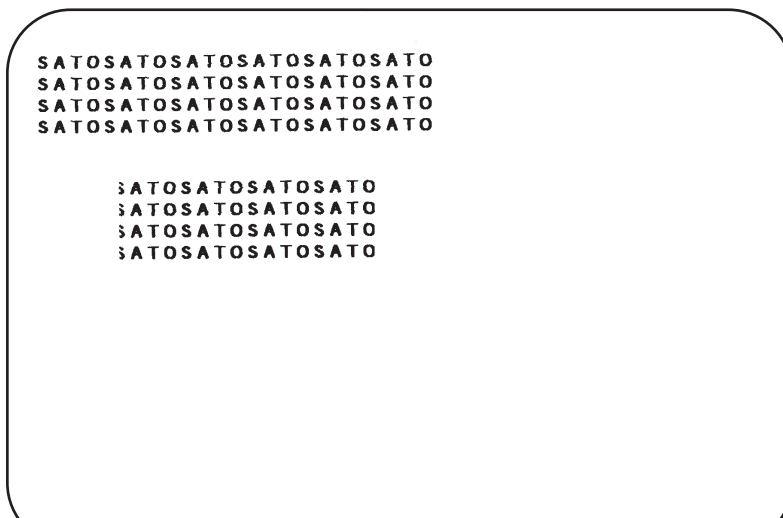

Special Notes

1. Use the Print Position commands (V and H) to locate the new area for the duplicate image.
2. Position of the new target area must not be inside the original image.
3. If you use the Rotate command, V, H, X and Y axes will be reversed.
4. If the reference area of the target image exceeds the print area, it will not be printed.
5. The allowable ranges for these fields are as follows:

	CT400	CT410
Horizontal aaaa to cccc	0001 to 0832	0001 to 1248
Vertical bbbb to dddd	0001 to 3200	0001 to 4800

Cut Job

Command Structure <ESC><NUL>aaaa
 <ESC>~aaaa

aaaa = Number of labels to print between each cut (1-9999)

Example: <ESC>~2

Placement: Following the Print Quantity command <ESC>Q

Default: <ESC>~1 (if cutter enabled)

Command Function To control the cutting of labels when using a SATO cutter unit with the printer. This command allows the cutting of a multi-part tag or label at a specified interval within a print job.

Input to Printer: <ESC>A
 <ESC>H0020<ESC>V0020<ESC>XB1ABC<ESC>Q3
 <ESC>~0002
 <ESC>Z

Printer Output: This set of commands will print 6 labels (3 x 2) with two labels between each cut.

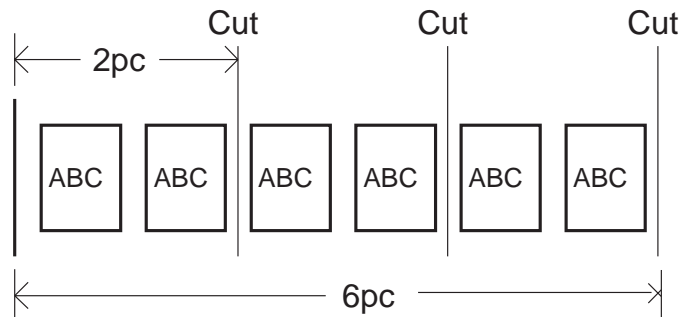

- Special Notes**
1. You must have the optional printer Cutter to use this function. Contact your SATO representative for more information.
 2. To use this command, the printer configuration must have the cutter option enabled. See Printer Configuration commands in this section manual.
 3. If the cutter option has been enabled in the printer configuration and the cut value (a = 0), the cutter is inactive.
 4. The <NUL> represents the ASCII 00 Hex character. A “~” (tilde) character or <NUL> character can be substituted in this command.
 5. When using the Cutter command, the total number of labels printed is the product of the cut value and the print quantity.

Cut

Command Structure

`<ESC>CTaaaa`

aaaa = Number of labels to print between each cut (1-9999)

Example: `<ESC>CT2`

Placement: Preceding the `<ESC>Q` Print Quantity command.

Default: `<ESC>CT1` (if cutter enabled)

Command Function

To control the cutting of labels when using a SATO cutter unit with the printer. This command allows the cutting of a multi-part tag or label at a specified interval within a print job. It differs from the `<ESC>~` Cut Job command in that it does not interact with the quantity command.

Input to Printer:

```
<ESC>A
<ESC>H0020<ESC>V0020<ESC>XB1ABC<ESC>CT0002
<ESC>Q7<ESC>Z
```

Printer Output:

This set of commands will print seven labels with two labels between each cut. One label will be left in the printer.

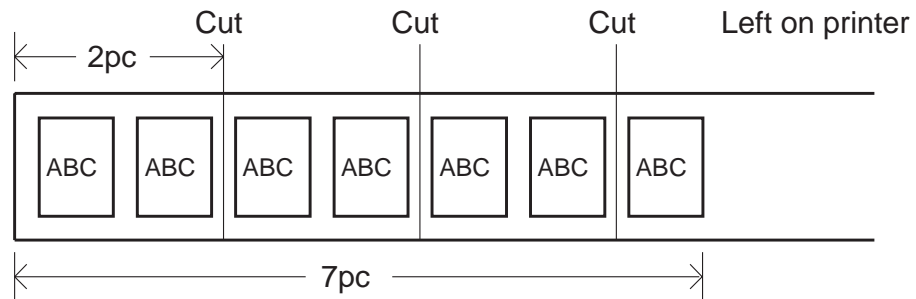

Special Notes

1. You must have the optional printer Cutter to use this function. Contact your SATO representative for more information.
2. To use this command, the printer configuration must have the cutter option enabled. See Configuration Commands in this section of the manual.
3. If the cutter option has been enabled in the printer configuration and the cut value ($a = 0$), the cutter is inactive.
4. This command is independent of the `<ESC>Q` Quantity command. It will cut the specified number of labels. If a printed label is left in the printer after the last cut, the `<ESC>YC` Cut/Eject command can be used to cut it.

Cut Last

Command Structure <ESC>YC

Example: <ESC>YC

Placement: Separate data stream sent to the printer

Default: None

Command Function To control the cutting of labels when using a SATO cutter unit with the printer. This command allows the cutting of a printed multi-part tag or label that is left in the printer after a job is cut using the <ESC>CT Cut command.

Input to Printer:
 <ESC>A
 <ESC>YC
 <ESC>Z

Printer Output: This command will cut the feed the last printed label to the cut position, cut the label and then backfeed to the head position in preparation for printing the next job.

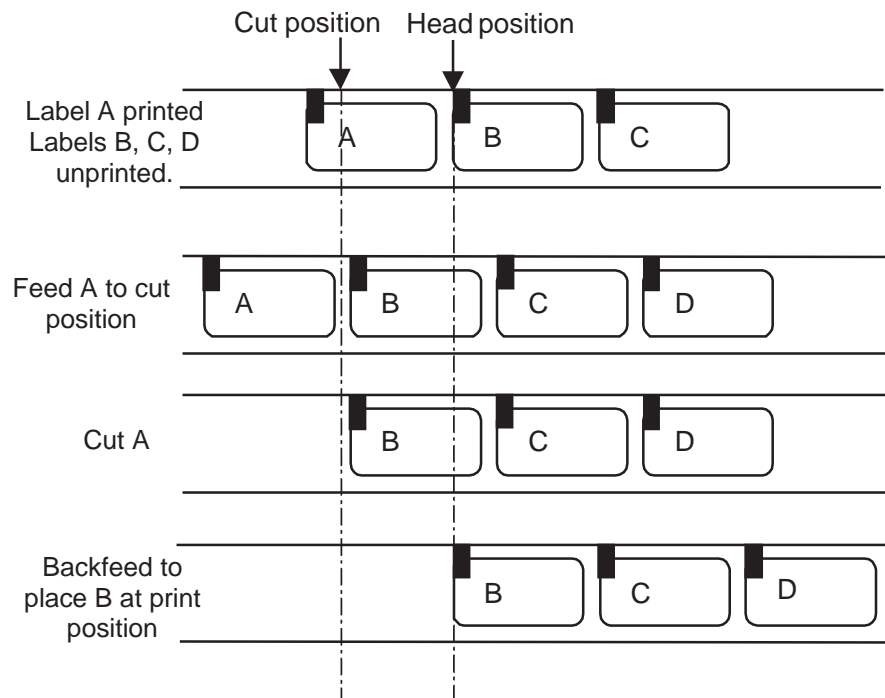

Notes

1. You must have the optional printer Cutter to use this function. Contact your SATO representative for more information.

Fonts U, S, M, OA, OB, XU, XS & XM

Command Structure

Font XU: <ESC> XU	Font U: <ESC> U
Font XS: <ESC> XS	Font S: <ESC> S
Font XM: <ESC> XM	Font M: <ESC> M
Font OA: <ESC> OA	Font OB: <ESC> OB

Example: See above

Placement: Preceding the data to be printed

Default: None

Command Function To print text images on a label. These are eight of the built-in fonts available on the printer. All matrices include descenders.

	NON-PROPORTIONAL	PROPORTIONAL⁽¹⁾
U	5W x 9H dot matrix	XU 5W x 9H dot matrix
S	8W x 15H dot matrix	XS 17W x 17H dot matrix
M	13W x 20H dot matrix	XM 24W x 24H dot matrix
OA	OCR-A font (see Note 7 for matrix)	
OB	OCR-B font (see Note 7 for matrix)	

(1) These fonts will be printed with non-proportional spacing only if preceded by an <ESC>PR command.

Input to Printer

```
<ESC>A<ESC>PS
<ESC>H0025<ESC>V0100<ESC>L0202<ESC>XUSATO "XU"
<ESC>H0025<ESC>V0175<ESC>L0202<ESC>XSSATO "XS"
<ESC>H0025<ESC>V0250<ESC>L0202<ESC>XMSSATO "XM"
<ESC>H0025<ESC>V0325<ESC>L0101<ESC>OASATO "OA"
<ESC>H0001<ESC>V0400<ESC>L0101<ESC>OBSATO "OB"
<ESC>H0300<ESC>V0100<ESC>L0202<ESC>USATO "U"
<ESC>H0300<ESC>V0175<ESC>L0202<ESC>SSATO "S"
<ESC>H0300<ESC>V0250<ESC>L0202<ESC>MSATO "M"
<ESC>Q1<ESC>Z
```

Printer Output

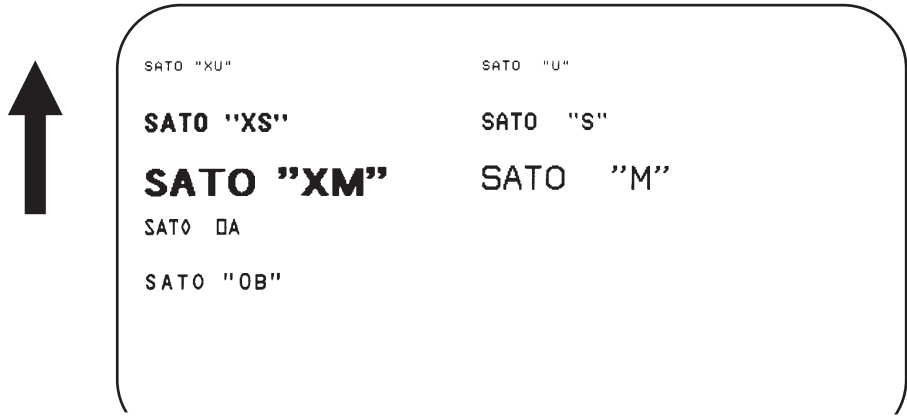

Special Notes

1. Characters may be enlarged through the use of the Character Expansion command.
2. Character spacing may be altered through the use of the Character Pitch command. The default is 2 dots between characters. It is recommended to use a spacing of 5 dots for OCR-A and 1 dot for OCR-B.
3. You may also create custom characters or fonts. See the <ESC>T Custom-Designed Characters command.
4. A font must be defined for each field to be printed. There is no default font.
5. Fonts U, S, M, OA and OB are identical to fonts U, S, M, OA and OB on the SATO M-8400 printer.
6. The proportionally spaced fonts XU, XS, XM, XL and XA can be printed with fixed spacing using the <ESC>PR Fixed Space command.
7. The matrices for the OA and OB fonts are scaled so that they will remain a constant size according to the OCR-A and OCR-B specifications when printed on different resolution printers.

	CT400	CT410
OA Font	15 dots W x 22 dots H	22 dots W x 33 dots H
OB Font	20 dots W x 24 dots H	30 dots W x 36 dots H

Font/Graphic Recall

Command Structure <ESC>A<ESC>RFaabbbb,nn...n

aa = Font ID number (00 to 80)
bbbb = Number of characters to print (0000-9999)
nn..n = Data to be printed

Example: <ESC>RF010004,ABCD

Placement: Within normal command stream

Default: None

Command Function To recall fonts or graphic previously stored in the printer memory using the Font/Graphic Store Utility Program.

Input to Printer <ESC>A
 <ESC>V0100<ESC>H0100
 <ESC>RF010001,G
 <ESC>Q1<ESC>Z

Printer Output

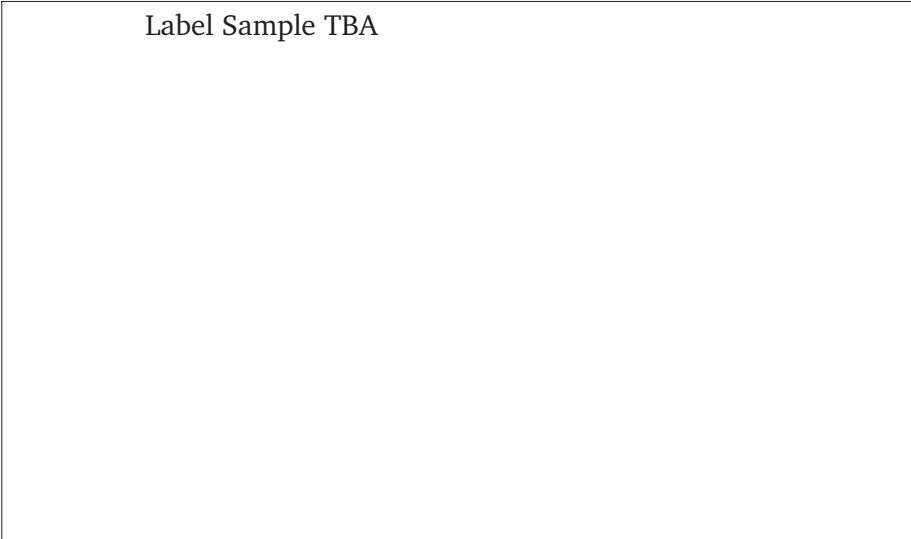

- Special Notes**
1. To store or delete a graphic or font, the Font/Graphic Store Utility program contained on the CD-ROM must be used.
 2. To recall a graphic, the parameter "bbbb" must be "0001" and the "nnn..n" parameter must be a "G".
 3. To recall a stored font, the SATO CX4XX Windows Driver should be used.

Font, Raster

Command Structure <ESC>A<ESC>RDabb,ccc,ddd,nn. . .n

a = A CG Times font style
 = B CG Triumvirate font style.
 bb = 00 for Normal font
 = 01 for Bold font
 ccc = Horizontal size (16 - 999 dots or P08 - P72)
 ddd = Vertical size (16 - 999 dots or P08 - P72)
 nn..n = Data to be printed.

Example: <ESC>RFA00,014,018ABCD

Placement: Within normal command stream

Default: None

Command Function To print point size characters created using font definitions.

Input to Printer

```
<ESC>A
<ESC>V0100<ESC>H0100
<ESC>RDA00,014,018ABCD
<ESC>V0200<ESC>H0100
<ESC>RFB10,018,014ABCD
<ESC>Q1<ESC>Z
```

Printer Output



Special Notes

1. The “cccc” Horizontal Size and “ddd” Horizontal Size parameters can be entered either in dots or points, but both parameters must use the same value types. If point size is used, the point size is preceded by a “P”.

Font, Vector

Command Structure	Specify Vector Font: <ESC> \$a,b,c,d
	Data for Vector Font: <ESC> \$(data)
	<ul style="list-style-type: none"> a = A Helvetica Bold (proportional spacing) B Helvetica Bold (fixed spacing) b = Font width (24-999) c = Font height (24-999 dots) d = Font variation (0-9) as follows: <ul style="list-style-type: none"> 0 Standard 1 Standard open (outlined) 2 Gray (mesh) pattern 1 3 Gray (mesh) pattern 2 4 Gray (mesh) pattern 3 5 Standard open, shadow 1 6 Standard open, shadow 2 7 Standard mirror image 8 Italic 9 Italic open, shadow
	Example: <ESC> \$A,100,200,0<ESC>\$(123456)
	Placement: Immediately preceding data to be printed.
	Default: None

Command Function To specify printing of the unique SATO vector font. The vector font allows large characters to be printed with smooth, round edges. Each character is made of a number of vectors (or lines), and will require slightly more printer compiling time.

Input to Printer

```
<ESC>A
<ESC>H0100<ESC>V0100<ESC>$A,100,100,0<ESC>$(SATO
<ESC>H0100<ESC>V0200<ESC>$=VECTOR FONT
<ESC>$A,200,300,8<ESC>H0100<ESC>V0350<ESC>$(SATO
<ESC>Q1<ESC>Z
```

Printer Output



Special Notes

1. The Pitch command can be used with Vector fonts.
2. If the font size designation is out of the specified range, a default value of 50 is used.
4. The font width and height values include ascenders, descenders and other space.
5. A font must be defined for each field to be printed. There is no default font.

Fonts WB, WL, XB & XL

Command Structure

Font WB: <ESC>**WB**a Font XB: <ESC>**XB**a
 Font WL: <ESC>**WL**a Font XL: <ESC>**XL**a

a = 0 Disables auto-smoothing of font
 1 Enables auto-smoothing of font (see notes below)

Example: <ESC>**WB1123456**

Placement: Preceding the data to be printed

Default: None

Command Function To print text images on a label. These are the four auto-smoothing fonts available on the printer.

NON-PROPORTIONAL		PROPORTIONAL ⁽¹⁾	
WB	18W x 30H dot matrix	XB	48W x 48H dot matrix
WL	28W x 52H dot matrix	XL	48W x 48H dot matrix

(1) These fonts will be printed with proportional spacing only if preceded by an <ESC>PS command.

Input to Printer

```
ESC>A<ESC>PS
<ESC>H0001<ESC>V0100<ESC>WB0SATO "WB0"
<ESC>H0001<ESC>V0185<ESC>WB1SATO "WB1"
<ESC>H0001<ESC>V0270<ESC>WL0SATO "WL0"
<ESC>H0001<ESC>V0355<ESC>WL1SATO "WL1"
<ESC>H0400<ESC>V0100<ESC>XB0SATO "XB0"
<ESC>H0400<ESC>V0185<ESC>XB1SATO "XB1"
<ESC>H0400<ESC>V0270<ESC>XL0SATO "XL0"
<ESC>H0400<ESC>V0355<ESC>XL1SATO "XL1"
<ESC>Q1<ESC>Z
```

Printer Output



Special Notes

1. Auto-smoothing (when enabled) is only effective if the character expansion rate is at least (3) times in each direction.
2. Characters may be enlarged through the use of the <ESC>L Character Expansion command.
3. Character spacing may be altered through the use of the <ESC>A Character Pitch command.
4. A font must be defined for each field to be printed. There is no default font.
5. The proportionally spaced fonts XU, XS, XM, XL and XB can be printed with fixed spacing using the <ESC>PS Proportional Space command.
6. The WB and WL fonts are not available in the initial production CT printers. Please contact your SATO representative and make arrangements to have your printer upgraded if these two fonts are not present.

Form Overlay, Recall

Command Structure <ESC>/

Example: <ESC>/

Placement: Must be preceded by all other data and placed just before the Print Quantity command (<ESC>Q)

Default: None

Command Function To recall the label image from the form overlay memory for printing. This command recalls a stored image from the overlay memory. Additional or different data can be printed with the recalled image.

Input to Printer <ESC>A
<ESC>H0001<ESC>V0125
<ESC>STHIS IS THE STORED IMAGE WITH A BARCODE
<ESC>H0001<ESC>V0165<ESC>B103100*12345*
<ESC>&<ESC>Z

<ESC>A<ESC>H0001<ESC>V0050
<ESC>STHIS IS RECALLING AND ADDING TO THE STORED IMAGE<ESC>/
<ESC>Q1<ESC>Z

Printer Output

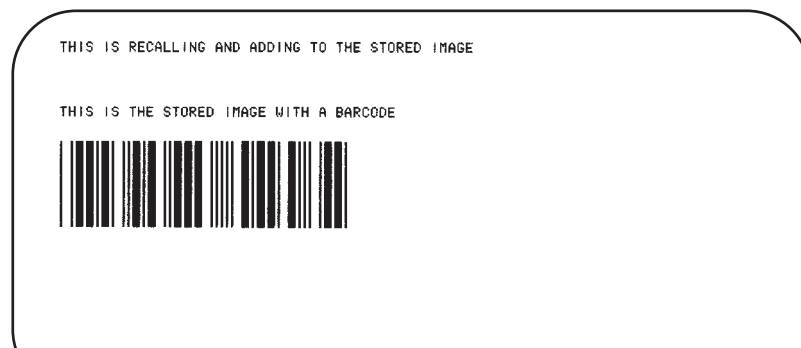

Special Notes

1. The overlay is stored using the <ESC>& Form Overlay Store command.
2. Only one Form Overlay can be stored in the CT4XX memory.

Form Overlay, Store

Command Structure	<ESC>&
	Example: <ESC>&
	Placement: Must be preceded by all other data and placed just before the Stop command (<ESC>Z)
	Default: None
Command Function	To store a label image in the volatile form overlay memory. Only one label image may be stored in this memory area at a time.
Input to Printer	<pre> <ESC>A <ESC>H0001<ESC>V0125 <ESC>STHIS IS THE STORED IMAGE WITH A BARCODE <ESC>H0001<ESC>V0165<ESC>B103100*12345* <ESC>& <ESC>Z </pre>
Printer Output	There is no output from this command. It stores the label image in the overlay buffer.
Special Notes	<ol style="list-style-type: none"> 1. Remember that this storage is volatile. Therefore, if the printer loses power, the overlay must be sent again. 2. The overlay is recalled using the <ESC>/ Form Overlay Recall command. 3. Form overlays do not have to be recompiled each time they are called to be printed and therefore may result in much faster print output. 4. The CT printers can only store one format.

Graphics, Custom

Command Structure <ESC>Gabbccc(data)

a = Specifies format of data stream to follow
 B Binary format
 H Hexadecimal format

bbb = Number of horizontal 8 x 8 blocks (001-248)

ccc = Number of vertical 8 x 8 blocks (001-267)

(data)= Hex data to describe the graphic image

Example: <ESC>**GH006006**
 See Appendix C for a detailed example

Placement: May be placed anywhere within the data stream after the necessary position commands.

Default: None

Command Function To create and print custom graphics (logos, pictures, etc.) on a label. The graphic image may be printed along with other printed data to enhance label appearance or eliminate the need for preprinted label stock. Using a dot-addressable matrix, design the graphic image in 8 dot by 8 dot blocks, then send it in a binary format to the printer.

Printer Input

```
<ESC>A
<ESC>H0100<ESC>V0100<ESC>GH006006
FFFFFFFFFFFFFFFFFFFFFFFFC00000000003
C00000000003C000FFFFFFFF3C00080000013
C00080000013C0009FFFFF13C00080000013
C00080000013C0009FFFFF13C00080000013
C00080000013C000FFFFFFFF3C00000000003
C00000000003C00000000003C00000000003
C00000000003C00000000003C00003C00003
C00007E00003C0000FF00003C0000FF00003
C0000FF00003C0000FF00003C00007E00003
C00003C00003C00003C00003C00003C00003
C00003C00003C00003C00003C00003C00003
C00003C00003C00003C00003C00003C00003
C00003C00003C00001800003C00000000003
C00000000003FFFFFFFFFFFFFFFFFFFFFFFF
<ESC>H0300<ESC>V0100<ESC>XSPLEASE PLACE YOUR DISK
<ESC>H0300<ESC>V0150<ESC>XSIN A SAFE PLACE
<ESC>Q1<ESC>Z
```

See Appendix C for a details on the data format.

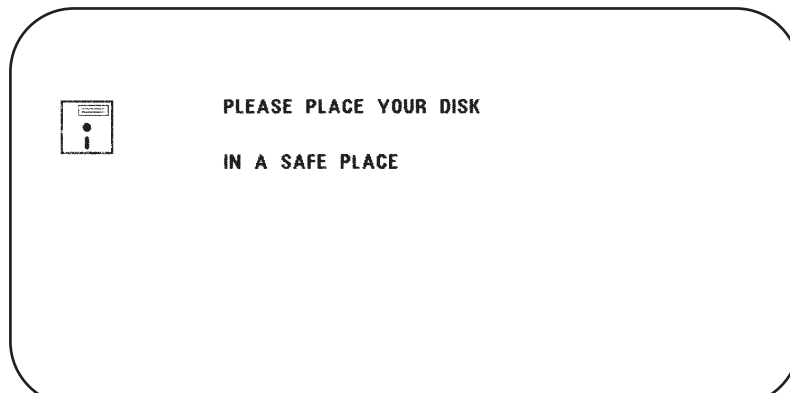
Printer Output**Special Notes**

1. Do not use ASCII <CR> or <LF> characters (carriage return or line feed) as line delimiters within the graphic data or the actual image will not be printed as specified.
2. A custom graphic cannot be enlarged by the <ESC>L Character Expansion command .
3. A custom graphic is not affected by either of the Rotation commands. Therefore, always design and locate your graphic image to print in the appropriate orientation.
4. The binary format reduces the transmission time by 50%.

Job ID Store

Command Structure <ESC>IDaa

aa = Job ID assigned (01 to 99)

Example: <ESC>ID09

Placement: Immediately following the <ESC>A in the job data stream.

Default: None

Command Function To add an identification number to a job. The status of the job can then be determined using the ENQ command in the Bi-Com status mode (See Section 5: Interface Specifications for more information).

Printer Input <ESC>A
<ESC>ID02
... Job ...
<ESC>Z

Printer Output There is no printer output as a result of this command. In the Bi-Com mode, the Job ID will be returned upon the receipt of a status request command.

Special Notes 1. Works only in Bi-Com mode. The Job ID number must be stored before Bi-Com status mode can be used.

2. If more than one ID number is sent in a single job, i.e.

 <ESC>A
 <ESC>ID01

 <ESC>ID02

the last number transmitted will be used.

Journal Print

Command Structure <ESC>J

Example: See above

Placement: Immediately following <ESC>A

Default: None

Command Function To print text in a line by line format on a label. By specifying this command, you automatically select Font XS with a Character Expansion of 2x2. You also establish a base reference point of H2,V2. The character pitch is 2 dots and the line gap is 16 dots. Simply issue an ASCII <CR> at the end of each text line.

Input to Printer

```
<ESC>A
<ESC>J WITH THE JOURNAL FEATURE
YOU CAN PRINT TEXT WITHOUT
USING ANY FONT COMMANDS
OR POSITION COMMANDS
<ESC>Q1<ESC>Z
```



WITH THE JOURNAL FEATURE
YOU CAN PRINT TEXT WITHOUT
USING ANY FONT COMMANDS
OR POSITION COMMANDS

Printer Output

Special Notes

1. Journal mode assumes a maximum label width . Otherwise, you may print where there is no label and damage your print head.
2. It is effective only for the current print job.

Lines and Boxes

Command Structure	Line	<code><ESC>FWaabcccc</code>
	aa	= Width of horizontal line in dots (01-99)
	b	= Line orientation H Horizontal line V Vertical Line
	cccc	= Length of line in dots (see Note 2 for max length)
	Box:	<code><ESC>FWaabbVccccHdddd</code>
	aa	= Width of horizontal side in dots (01-99)
	bb	= Width of vertical side in dots (01-99)
	cccc	= Length of vertical side in dots (see Note 2 for max length)
	dddd	= Length of horizontal side in dots (see Note 2 for max length)
	Example:	<code><ESC>FW02H0200</code>
	Placement:	Following the necessary positioning commands
	Default:	None
Command Function	To print horizontal lines, vertical lines, and boxes as images on the label.	
Input to Printer	<code><ESC>A</code> <code><ESC>H0100<ESC>V0100<ESC>FW20H0200</code> <code><ESC>H0320<ESC>V0100<ESC>FW20V0200</code> <code><ESC>H0350<ESC>V0100<ESC>FW1010H0200V0200</code> <code><ESC>Q1<ESC>Z</code>	



Printer Output

Special Notes

1. It is recommended that all lines and boxes be specified in the normal print direction.

LINE/BOX LENGTH	CT400	CT412
Horizontal cccc	0001 to 0832	0001 to 1248
Vertical cccc	0001 to 3200	0001 to 4800

2. The maximum allowable lengths for the different CT printers are as follows.

Job Name

Command Structure	<ESC> WKnnn. . . n nn..n = Job Name assigned, up to 16 ASCII characters Example: <ESC> WKSATO Placement: Immediately following the <ESC>A in the job data stream. Default: None
Command Function	This command is to identify a particular job using a descriptive name
Printer Input	<ESC>A <ESC> WKSATO ... Job ... <ESC>Z
Printer Output	There is no printer output as a result of this command. The information is returned to the host upon receipt of a Bi-Com status request.
Special Notes	<ol style="list-style-type: none">1. Works only in Bi-Com mode. The Job Name must be stored before Bi-Com status mode can be used.2. If more than one Job Name is sent in a single job, i.e. <ESC>A <ESC>WKSATO <ESC>WKSATO AMERICA the last name transmitted will be used.

Label/Tag Select

Command Structure	<ESC>YEa a = 0 Adhesive labels on liner 1 Tags Example: See above Placement: Separate data stream sent to the printer. Default: Printer default setting
Command Function	To select adhesive backed labels or non-adhesive tags
Input to Printer	<ESC>A <ESC>YE0 <ESC>Z
Printer Output	There is no printer output for this command
Special Notes	<ol style="list-style-type: none">1. When power is recycled, the Label/Tag setting returns to the default value specified by the <ESC>PG command. To change the default setting in the printer, use the <ESC>PG Printer Configuration command or the Printer Setting Utility program on the CD-ROM.2. This command is used to control last label printing. If Label is selected, the printer will stop printing as soon as a Label Out condition is detected. If Tag is selected, the printer will continue to print after a Label Out signal is detected until the current label is printed.

Line Feed

Command Structure

<ESC>**E**aaa

aaa = Number of dots (001-999) between the bottom of the characters on one line to the top of the characters on the next line

Example: <ESC>**E010**

Placement: Preceding the text that will use the line feed function

Default: None

Command Function

To print multiple lines of the same character size without specifying a new print position for each line. With the Line Feed command, specify the number of dots you want between each line. Then, send an ASCII <CR> at the end of each line of text. The printer automatically identifies the size of the last character, moves down the number of dots specified, and begins printing the next line.

Input to Printer

```
<ESC>A
<ESC>E010<ESC>H0050<ESC>V0050<ESC>L0202<ESC>S
THIS IS THE 1ST LINE<CR>
THIS IS THE 2ND LINE<CR>
THIS IS THE 3RD LINE<CR>
<ESC>Q1<ESC>Z
```

Printer Output



```
THIS IS THE 1ST LINE
THIS IS THE 2ND LINE
THIS IS THE 3RD LINE
```

Special Notes

1. This command can be used for text and for bar codes.
2. It is effective only for the current data stream.
3. When printing lines or boxes in the same data stream with the Line Feed command, the Lines and Boxes command should be specified last, preceding <ESC>Q Quantity command.

4. This command is invalid only if the value specified is zero.
5. Following this command with a <CR> character will allow you to print with auto line feed. In this case, the print position will be determined from the value specified in the command and the H value set in the printer. However, if you specify several H values after this command, the print position will be determined by the H value last specified. You must redefine the font to be used after each H command.

Media Size

Command Structure <ESC>A1aaaabbbb

aaaa = Vertical Media Size in dots (0 to Vmax)
bbbb = Horizontal Media Size in dots (0 to Hmax)

Example: <ESC>A108323200

Placement: Separate data stream to the printer.

Default: <ESC>A**108323200** for CT400
 <ESC>A**108324800** for CT410

Command Function To set the size of the media.

Input to Printer: <ESC>A
 <ESC>A108323200
 <ESC>Z

Printer Output: There is no printer output resulting from this command. It is used to automatically adjust the offset values for the size of label being used.

- Special Notes**
1. The Base Reference point is always the on the right (looking at the front of the printer) side of the print head. This command adjusts the Base Reference Point to correspond with the right edge of the loaded media.
 2. If the label size is changed, then this command must be respecified to center the print image on the label.
 3. All eight variables (“aaaa” and “bbbb”) must be included in this command.

Off-Line

Command Structure	<ESC>@
	Example: See above
	Placement: Anywhere in the print job between <ESC>A and <ESC>Z
	Default: None
Command Function	To specify the printer to come to an off-line state. When used within a print job, the printer goes off-line after finishing the print job.
Input to Printer	<ESC>A <ESC>@ <ESC>Z
Printer Output	There is no printer output for this command. The printer is placed in the Off-Line mode as soon as the current print job is finished.
Special Notes	<ol style="list-style-type: none">1. You must press the LINE key on the front panel to return the printer to an on-line status (see Operator Panel in Section 2 of this manual).2. Remember, when using this command, that if the print job specifies <ESC>Q10, all ten labels will print before the printer will go off-line.

Postnet

Command Structure <ESC>**BP**n...n

n...n = 5 digits (Postnet-32 format)
 6 digits (Postnet-37 format)
 9 digits (Postnet-52 format)
 11 digits (Postnet-62, Delivery Point format)

Example: <ESC>**BP123456789**

Placement: Immediately preceding the data to be encoded

Default: None

Command Function To print Postnet bar codes

Printer Input <ESC>A
 <ESC>H0100<ESC>V0120<ESC>**BP94089**
 <ESC>H0100<ESC>V0160<ESC>**BP123456**
 <ESC>H0100<ESC>V0200<ESC>**BP123456789**
 <ESC>H0100<ESC>V0240<ESC>**BP12345678901**
 <ESC>Q1<ESC>Z

Printer Output



- Special Notes**
1. If the number of data digits does not match those listed, the command is ignored.
 2. Only numeric data will be accepted.

Print Darkness

Command Structure	<code><ESC>#Eab</code> a = Print Darkness Range (A thru F) b = Print darkness value (1 thru 5) Example: <code><ESC>#E2A</code> Placement: Must be placed immediately after <code><ESC>A</code> and immediately before <code><ESC>Z</code> in its own separate data stream Default: Value set in printer using the <code><ESC>PG</code> Printer Setting
Command Function	To specify a new print darkness setting. This command allows software control of the darkness setting for unique media and ribbon combinations.
Input to Printer	<code><ESC>A</code> <code><ESC>#EA2</code> <code><ESC>Z</code>
Printer Output	There is no printer output for this command.
Special Notes	<ol style="list-style-type: none">1. This becomes the new setting in the printer configuration for all subsequent print jobs, unless changed. The setting is stored in non-volatile memory and is not affected by cycling power.2. The allowable Print Darkness Level setting is "A" for SATO ThechoTherm direct thermal media and "B" for SATO TechnoTherm coated thermal transfer media.

Print Position

Command Structure

Horizontal Position: <ESC>**Haaaa**

Vertical Position: <ESC>**Vbbbb**

aaaa = Number of dots horizontally from the base reference point
 (1 to maximum) See Note 2.

bbbb = Number of dots vertically from the base reference point
 (1 to maximum) See Note 2.

Example: <ESC>**H0020**<ESC>**V0150**

Placement: Preceding any printed field description of lines/boxes,
 fonts, bar codes or graphics.

Default: <ESC>H0001
 <ESC>V0001

Command Function

The Horizontal and Vertical commands specify the top left corner of a field or label, using the current base reference point as an origin. They also establish a reference point for subsequent fields until the next horizontal and/or vertical print position command is issued.

Input to Printer

```
<ESC>A
<ESC>H0025<ESC>V0050<ESC>L0303<ESC>MSATO
<ESC>H0100<ESC>V0150<ESC>MSATRO
<ESC>Q1<ESC>Z
```

Printer Output



Special Notes

1. The print position of a field is affected by the <ESC>A3) command.

2. If any part of an image is placed past the maximum number of dots, that part of the image will be lost.
3. If any part of an image is placed past maximum allowable dots across the label, that part of the image will be lost.
4. If you attempt to print where there is no paper, you may damage the print head.

	CT400	CT410
Maximum Print Width aaa	832 dots 4.1 in. 104 mm	1248 dots 4.1 in. 104 mm
Maximum Print Length bbb	3200 dots 15.7 in. 400 mm	4800 dots 15.7 in. 400 mm

5. For these commands, the leading zeroes do not have to be entered. The command V1 is equivalent to V0001.

Print Quantity

Command Structure	<code><ESC>Qaaaaaa</code> aaaaaa = Total number of labels to print (1-999999) Example: <code><ESC>Q500</code> Placement: Just preceding <code><ESC>Z</code> , unless Cut command exists, then preceding that. This command must be present in every print job. Default: None
Command Function	To specify the total number of labels to print for a given print job.
Input to Printer	<code><ESC>A</code> <code><ESC>H0100<ESC>V0100<ESC>WB1CT400</code> <code><ESC>Q3</code> <code><ESC>Z</code>
Printer Output	Three labels containing the data "CT400" will be printed.
Special Notes	<ol style="list-style-type: none">1. To pause during a print job, you must press the LINE key on the Operator Panel.2. To cancel a print job, you must turn off the printer, or you may send the <code><CAN></code> code if using the Bi-Com mode. Multi-Buffer jobs can be cleared with the <code><ESC>*</code> Clear Print Jobs and Memory command.3. When used with the <code><ESC>F</code> Sequential Numbering command, the Print Quantity value should be equal to the total number of labels to be printed.4. If you do not specify a Print Quantity, the printer will not print a label.5. For this command, leading zeroes do not have to be entered. The command Q1 is equivalent to Q000001.

Print Speed

Command Structure <ESC>**CSa**

a	=	1	2 ips (50 mm/s)
	=	2	3 ips (75 mm/s)
	=	3	4 ips (100 mm/s)
	=	5	5 ips (125 mm/s)
	=	6	6 ips (150 mm/s)

Example: <ESC>**CS3**

Placement: Must be placed immediately after <ESC>A and immediately before <ESC>Z in its own separate data stream

Default: As previously set in the printer configuration

Command Function To specify a unique print speed through software for a particular label. This allows flexibility in finding the best performance and quality for the particular label format, media, and ribbon. All subsequent labels will print at this speed unless the speed is changed with this command or through the Operator Panel.

Input to Printer <ESC>A
 <ESC>**CS5**
 <ESC>Z

Printer Output There is no printer output for this command. It sets the print speed of the printer.

Special Notes

1. This becomes the new setting in the printer configuration for all subsequent print jobs, unless changed. The setting is stored in non-volatile memory and is not affected by cycling the power.
2. Parameters of "5" and "6" are not valid for the CT410.

Repeat Label

Command Structure	<ESC>C
Example:	See above
Placement:	Must be placed immediately after <ESC>A and immediately before <ESC>Z in its own separate data stream
Default:	None
Command Function	To print duplicate of the last label printed
Input to Printer	<ESC>A <ESC>C <ESC>Z
Printer Output	A duplicate of the previous label will be printed.
Special Notes	1. This command will have no effect if the power to the printer was cycled off and back on since printing the previous label.

Replace Data (Partial Edit)

Command Structure <ESC>**0** (<ESC>zero)

Example: See above

Placement: Must follow <ESC>A and precede all other print data

Default: None

Command Function To replace a specified area of the previous label with new data. This command will cause the previous label to print along with any changes specified within the current data stream.

Input to Printer

```
<ESC>A
<ESC>H0050<ESC>V0020<ESC>XB08400
<ESC>H0050<ESC>V0085<ESC>XB1SATO
<ESC>H0050<ESC>V0150<ESC>XL0SATO
<ESC>H0050<ESC>V0215<ESC>XL1SATO
<ESC>Q1<ESC>Z
```

```
<ESC>A
<ESC>0<ESC>H0050<ESC>V0020<ESC>XB0SATO
<ESC>Q1<ESC>Z
```

Printer Output

Special Notes



```
8400
SATO

SATO

SATO
```



```
SATO
SATO

SATO

SATO
```

1. Specify the exact same parameters for the image to be replaced as were specified in the original data stream, including rotation, expansion, pitch, etc. This will ensure that the new data will exactly replace the old image. If the replacement data contains fewer characters than the old data, then the characters not replaced will still be printed.
2. This command will not function if the power has been cycled off and back on since the last label was printed.
3. Proportional Pitch text cannot be used with this command.

Reverse Image

Command Structure <ESC>(aaaa,bbbb

a = Horizontal length in dots of reverse image area
b = Vertical height in dots of reverse image area.
See Note 6 for field ranges

Example: <ESC>(100,50

Placement: This command must be preceded by all other data and be placed just before <ESC>Q

Default: None

Command Function To reverse an image area from black to white and vice versa. Use the Print Position commands (<ESC>H and <ESC>V) to locate the top left corner of the reverse image area.

Input to Printer

```
<ESC>A
<ESC>H0050<ESC>V0120<ESC>L0202<ESC>WL1REVERSE
<ESC>H0250<ESC>V0300<ESC>L0202<ESC>WL1HALF
<ESC>H0040<ESC>V0110<ESC>(370,100
<ESC>H0240<ESC>V0290<ESC>(220,47
<ESC>Q1<ESC>Z
```

Printer Output

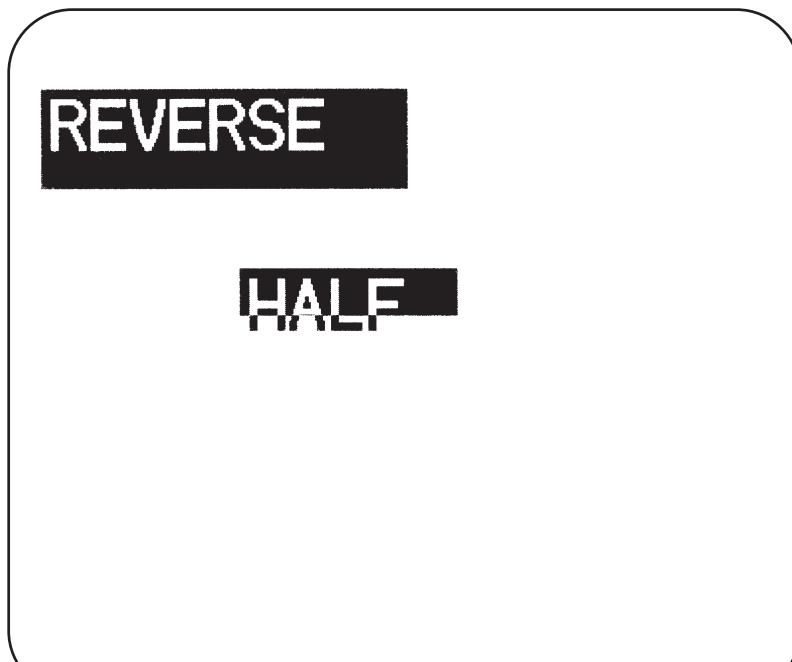

Special Notes

1. A reverse image area is affected by the rotate commands. Therefore, always assume the printer is in the normal print orientation when designing and sending the Reverse Image command.
2. If using reverse images with the form overlay, place this command before the Form Overlay command in the data stream.
3. If the Rotate commands are used with this command, the V and H parameters are reversed.
4. If the height and width to be reversed contain other than alphanumeric data, the area is not printed.
5. If the values specified exceed the maximum ranges, the reverse image is not created.
6. The maximum allowable settings are as follows:

	CT400	CL412
Horizontal aaaa	0001 to 0832	0001 to 1248
Vertical bbbb	0001 to 3200	0001 to 4800

Rotate, Fixed Base Reference Point

Command Structure <ESC>%a

a = 0 Sets print to normal direction
 1 Sets print to 90°CCW
 2 Sets print to 180° rotated (upside down)
 3 Sets print to 270° CCW

Example: <ESC>%3

Placement: Preceding any printed data to be rotated

Default: <ESC>%0

Command Function To rotate the print direction in 90° increments without changing the location of the base reference point. The diagram below illustrates the use of the <ESC>% Rotate command. Note that the entire print area is shown, but your label will probably not be as large as the entire area.

Input to Printer

```
<ESC>A
<ESC>%0<ESC>H0200<ESC>V0100<ESC>MNORMAL DIRECTION
<ESC>%1<ESC>H0200<ESC>V0300<ESC>MONE
<ESC>%2<ESC>H0200<ESC>V0400<ESC>MTWO
<ESC>%3<ESC>H0200<ESC>V0500<ESC>MTHREE
<ESC>Q1<ESC>Z
```

Printer Output

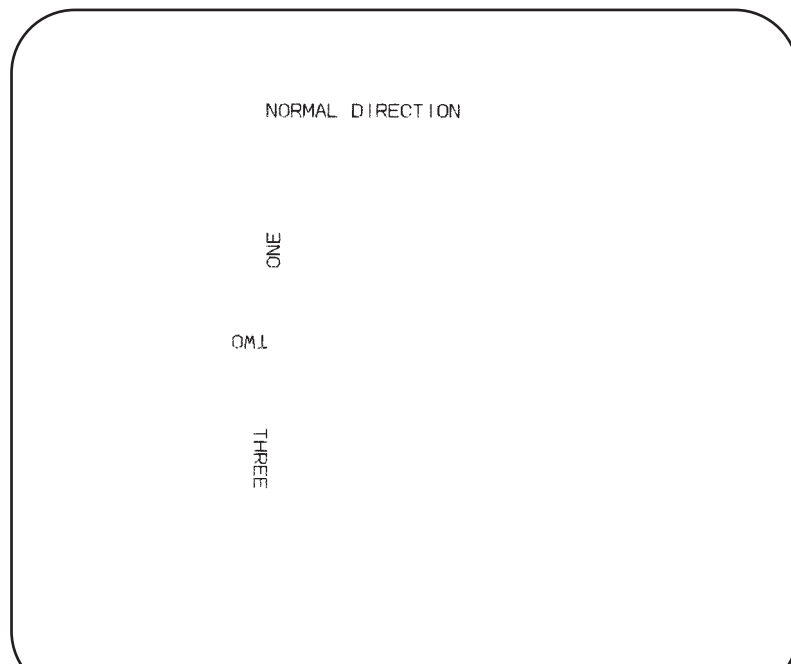

Sequential Numbering

Command Structure <ESC>**Faaabcccc,dd,ee,f**

aaaa = Number of times to repeat the same data (0001-9999)

b = Plus or minus symbol (+ for increments; - for decrements)

cccc = Value of step for sequence (0001-9999)

,dd = Number of digits for sequential numbering (01-99). The first incrementing character position starts after the positions exempted from sequential numbering as specified in ee. If these digits are left out, the default is 8.

,ee = Number of digits free from sequential numbering (00-99) starting with the right most position. If these digits are left out, the default is 0.

,f = 0 Decimal count
 1 Hexadecimal count

Decrementing

004321321

Free from Decrementing

Example: <ESC>**F0001-001,04,03,0**

In this example, the right most (least significant) three digits would not decrement and the next four would decrement.

Placement: Preceding the starting value to be incremented or decremented.

Default: None

Command Function To allow the ability to print sequential fields (text, bar codes) where all incrementing is done within the printer. Up to eight different sequential fields can be specified per label. Sequencing is effective for up to 99-digit numeric data within each field.

Input to Printer

```
<ESC>A<ESC>H0100<ESC>V0100<ESC>MSERIAL NUMBER:
<ESC>H0100<ESC>V0200<ESC>F0001+005
<ESC>L0202<ESC>M1000
<ESC>Q2<ESC>Z
```

Printer Output

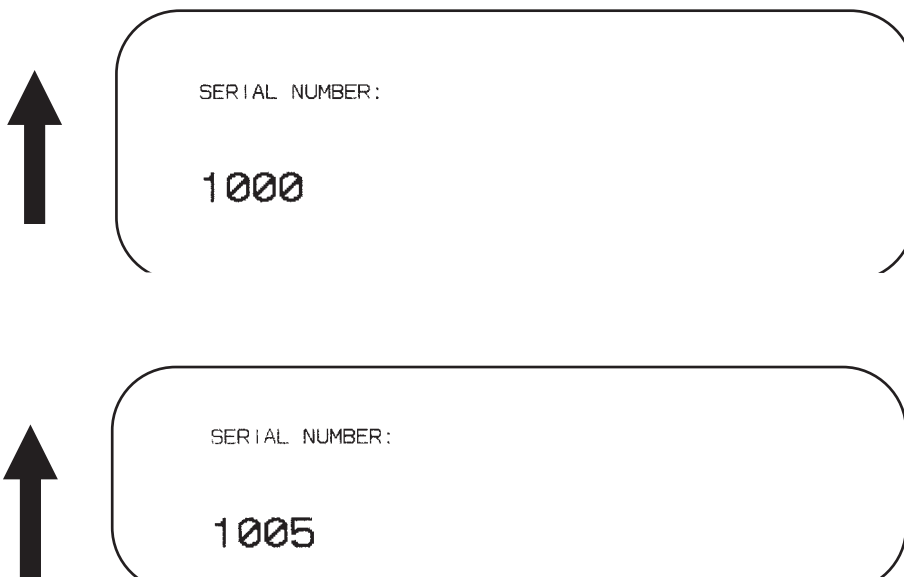

Special Notes

1. The value specified for Print Quantity should be equal to the number of different sequential values desired multiplied by the number of repeats specified.

Example:

To print 2 sets each of the numbers 1001-1025 on separate labels, we need 50 total labels. The commands would be as follows:

```
<ESC>A
<ESC>H0100<ESC>V0100<ESC>F0002+001<ESC>XM1001
<ESC>Q50
<ESC>Z
```

2. It is necessary to specify the print position for each sequential field on a label.
3. Up to eight different sequential fields can be specified per label.
4. This command ignores alpha characters in the sequential number field for decimal counting after the last hexadecimal (F) character.
5. This command can not be used with the following commands:
 - Copy Image
 - Reverse Image
 - Line Feed
6. The “a” field can be omitted. If it is omitted, the sequential numbering will be a decimal count.

Start/Stop Label

Command Structure	Start Command: <ESC>A Stop Command: <ESC>Z Example: See above Placement: <ESC>A must precede data <ESC>Z must follow data Default: None
Command Function	For all print jobs, the Start command must precede the data, and the Stop command must follow. The print job will not run properly if these are not in place.
Input to Printer	<ESC>A <ESC>H0001<ESC>V0100<ESC>WB1SATO <ESC>H0130<ESC>V0200<ESC>B103150*CT400* <ESC>H0170<ESC>V0360<ESC>L0202<ESC>S*CT400* <ESC>Q1<ESC>Z
Printer Output	There is not output for these commands they are not accompanied by other label printing commands. However, these commands must precede and follow each print job sent to the printer.

Two-Dimensional Symbols

The following commands are used to create the two-dimensional symbologies supported by the CT Series printers.

Two-Dimensional Bar Codes

Data Matrix, Data Format

Command Structure <ESC>**BX**aa**bb**cc**dd**eee**fff**ghh

aa = Format ID. 01-06 or 11-16.
 bb = Error correction level. 00, 05, 08, 10, 14 or 20. All other values entered will be processed as a 00.
 cc = Horizontal cell size. 03 - 12 dots/cell.
 dd = Vertical cell size. 03 - 12 dots/cell.
 eee = Number of cells in one line. Must use 000 to optimize.
 f f f = Number of cell lines. Must use 000 to optimize.
 g = Mirror Image
 0 = Normal Print
 1 = Reverse Print
 hh = Guide Cell Thickness. 01-15. 01 indicates normal type.

Example: <ESC>**BX030805050000000001**

Placement: Immediately preceding data to be encoded

Default: None

Command Function To designate the format for a Data Matrix two-dimensional bar code image on a label.

Printer Input

```
<ESC>A
<ESC>%0<ESC>V0100<ESC>H0100<ESC>BX05051010000000001
<ESC>DCDATA MATRIX DATA MATRIX
<ESC>Q1<ESC>Z
```

Printer Output

There is no printer output as a result of this command. See the <ESC>DC Print Data command for printer output.

Special Notes

1. If any of the parameters entered are outside the valid range, a symbol will not be printed when the <ESC>DC Print Data command is sent to the printer.
2. The number of cells per line (eee) and the number of cell lines (fff) should be specified as all zeroes, allowing the printer to automatically calculate the optimum configuration for the symbol.
3. The Reference Point for the Data Matrix symbol is the upper-left corner. If an <ESC>R Rotate command is used to rotate the symbol, it will rotate in the counter-clockwise direction.

4. The maximum data capacity for the Format ID “aa” and ECC “bb” is defined by the following table. The printer only supports the Format ID’s defined in the table. If ECC200 (aa = 20) is selected, the Format ID specified by “bb” is ignored.

ECC Level (bb)	Format ID (aa)					
	01	02	03	04	05	06
00 (ECC000)	500	452	394	413	310	271
05 (ECC050)	457	333	291	305	228	200
08 (ECC080)	402	293	256	268	201	176
10 (ECC100)	300	218	190	200	150	131
14 (ECC140)	144	105	91	96	72	83
20 (ECC200)	Numeric				3116	
	Alphanumeric				2336	
	ISO 8-bit (01H - FFH)				1556	

5. The character set for each Format ID is:

ID NUMBER	CHARACTER SET	ENCODING SCHEME
16 Bit CRC		
01	Numeric, Space	Base 11
02	Upper Case Alpha, Space	Base 27
03	Upper Case Alpha, Space, Comma, Period, Slash, Minus	Base 41
04	Upper Case Alphanumeric, Space	Base 37
05	ASCII 7-bit, Full Keyboard (20H - 7FH)	ASCII
06	ISO 8-bit, International (20H - FFH)	8-Bit

Two-Dimensional Bar Codes

Data Matrix, Print Data

Command Structure <ESC>**DCxx...x**

xx...x= Data, maximum of 500 characters

Example: <ESC>**DC00006000**

Placement: Immediately following the <ESC>BC Data Format designation command or the <ESC>FX Sequential Numbering command.

Default: None

Command Function To print a Data Matrix two-dimensional bar code image on a label.

Printer Input

```
<ESC>A  
<ESC>%0<ESC>V0100<ESC>H0100<ESC>BX05051010000000001  
<ESC>DCDATA MATRIX DATA MATRIX  
<ESC>Q1<ESC>Z
```

Printer Output



Special Notes

1. If an <ESC>BX Data Format designation command contains any parameters out of the valid range, no symbol will be printed when this command is sent.

Two-Dimensional Bar Codes

Data Matrix, Sequential Numbering

Command Structure <ESC>FXaaabcccddeee

aaa = Number of duplicate labels to be printed (001 - 999)

b = Increment or Decrement

+ = Increment

- = Decrement

ccc = Increment/Decrement Steps (001 - 999)

ddd = Sequential numbering start position (001 - 999)

Referenced to left side.

eee = Incremented data length measured from start position (001 - 999)

Placement: Immediately following the <ESC>BX Data Format designation command and preceding the <ESC>DC Print Data Command.

Default: None

Command Function To print sequential numbered Data Matrix symbols.

Printer Input

```
<ESC>A<ESC>V0100<ESC>H0100
<ESC>BX03081010000000001
<ESC>FX002+001005003<ESC>DC000060000
<ESC>Q4<E SC>Z
```

Printer Output

Label Set #1



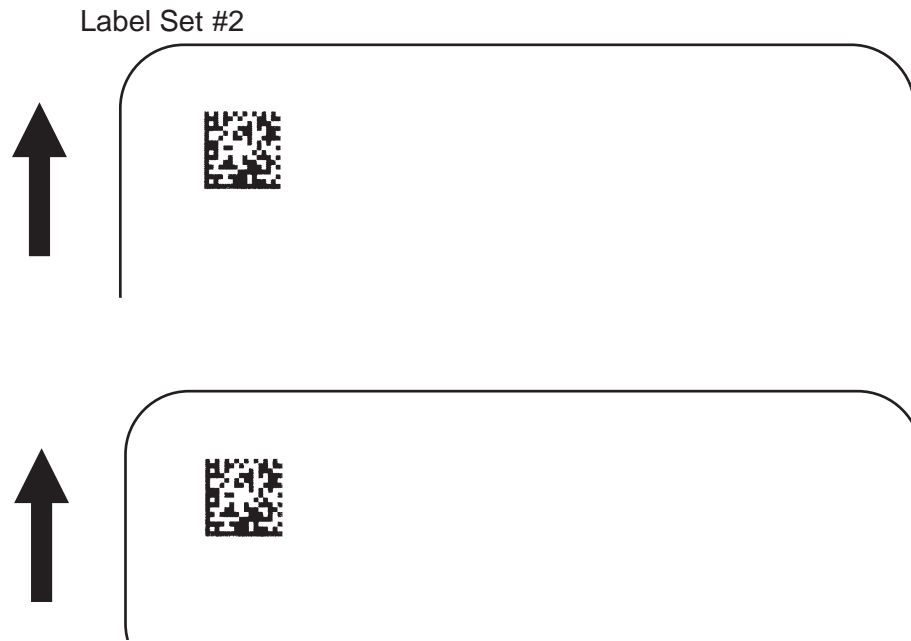

1. The maximum number of <ESC>FX Sequential Numbering commands that can be used in one job is eight.
2. In the example above four total labels will be printed (<ESC>FX002+005003<ESC>DC00006000), the sequential numbering will start at position 5 and the three digits “600” will be incremented in steps of 1. A total of two sets of labels will be printed, the first set of two labels with the value “00006000” and the next two label set with the value “00006010”.

	Label Set #1		Label Set #2
1st Label	00006000	3rd Label	00006010
2nd Label	00006000	4th Label	00006010

3. The <ESC>Q Label Quantity command must be set for the total number of labels to be printed. In the above example, the value for the <ESC>Q command should be 2 sets x 2 labels/set = 4. If, in the above example, it was set to a value of “1”, only the first label would be printed.

Two-Dimensional Bar Codes

Maxicode

Command Structure <ESC>BVa,b,c,ddddddddd,eee,fff,gggg.....<ESC>

- a = Position of Maxicode symbol within the set, when used in a structured append format 1~8.
- b = Total number of Maxicode symbols in the set, when used in a structured format 1~8.
- c = 2 For Mode 2 Structured Carrier Message for Domestic U.S. UPS shipments
 3 For Mode 3 Structured Carrier Message for International UPS shipments
 4 Standard symbol
 5 Not currently supported
 6 Reader programming
- ddd..ddd 9 digit numeric Postal Code
- eee = 3 digit numeric Country Code
- fff = 3 digit numeric Service Class
- gg..g = Data, terminated by <ESC>

Example: <ESC>BV1,2,3,123456789,222,333,MESSAGE<ESC>

Placement: Immediately preceding data to be encoded

Default: None

Command Function To print a Maxicode two-dimensional bar code image on a label. See Appendix B for specific information on using each individual bar code symbol.

Command Function To print a UPS Maxicode symbol.

```
<ESC>A<ESC>V0100<ESC>H0100
<ESC>BV1,1,2,123456789,840,001,]<RS>01<GS>961Z01547089<GS>UPSN
<GS>056872<GS>349<GS>99999999<GS>001/005<GS>029<GS>N<GS>
<GS>LENEXA<GS>KS<RS><EOT>
<ESC>Q001<ESC>Z
```

Printer Output

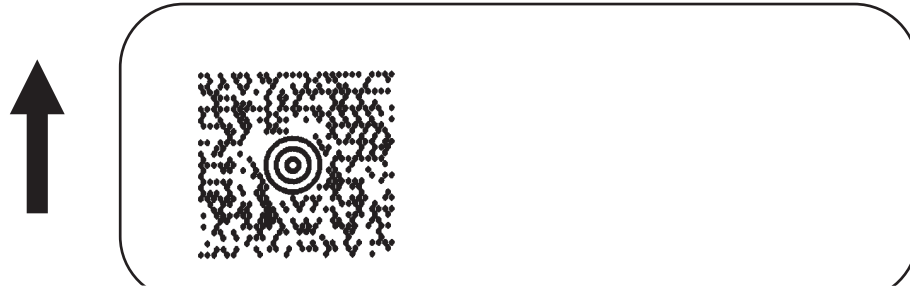

Special Notes

1. Please refer to UPS Publication “Guide to Bar Coding with UPS Online - Version 5” for the UPS secondary message data format requirements and the latest format requirements.
2. This command implements Maxicode AIM I.S.S. (UPS Version 3.1) symbol.
2. The following modes are supported.

MODE	POSTAL CODE	COUNTRY CODE	SERVICE CLASS	MESSAGE LENGTH
2	9 digits max numeric only	3 digits max numeric only	3 digits max numeric only	84 characters alphanumeric
3	6 digits fixed alphanumeric	3 digits max numeric only	3 digits max numeric only	84 characters alphanumeric
4 6	“000000” fixed data	“000” fixed data	“000” fixed data	91 characters alphanumeric

Two-Dimensional Bar Codes

PDF417

Command Structure <ESC>**BKaabbcddeefffn...n**

- aa = Minimum module dimension (03-09 dots). Will not print if values of 01, 02 or greater than 10 are specified.
- bb = Minimum module pitch dimension (04-24 dots). Will not print if values of 01, 02, 03 or greater than 25 are specified.
- c = Security (error detection) Level (1-8).
- dd = Code words per line (01-30). If 00 is specified for both dd and ee, the printer automatically optimizes the number of rows per symbol.
- ee = Rows per symbol (00 or 03-40). If 00 is specified for both dd and ee, the printer automatically optimizes the number of rows per symbol.
- fff = Number of characters to be encoded (0001-2700).
- nn...n = Data to be printed.

Example: <ESC>**BK0304400000021**

Placement: Immediately preceding data to be encoded

Default: None

Command Function To print a PDF417 two-dimensional bar code image on a label.

Printer Input

```
<ESC>A
<ESC>V0100<ESC>H0100<ESC>BK0607400000021PDF417 PDF417 PDF417
<ESC>Q1<ESC>Z
```

Printer Output



Special Notes

1. When the code words per line and the number of rows per symbol ("dd" and "ee") are set to all zeroes, the printer will calculate the optimum configuration.

2. If the product of the values entered for “dd” and “ee” are not equal to or less than the value of “fff” (i.e., “fff” \geq “dd” x “ee”), an error will occur and the symbol will not be printed. It is recommended that these values each be set to “000” and the printer be allowed to automatically calculate the optimum values.
3. The values for “dd” and “ee” need to be made larger if the security level is increased.
4. The maximum data length is 2700 characters, but may be less depending upon:
 - the minimum module dimension (“aa”)
 - the security level specified by “c”.
 - the number of data characters
5. The Reference Point of the PDF417 symbol is the upper-left corner.
6. The <ESC>F Sequential Numbering command cannot be used with this command.
7. The <ESC>E Line Feed command cannot be used with this command.
8. The Macro and Truncated PDF417 symbols are not supported.
9. The values 00_H thru 1F_H can be specified as print data.
10. This command can be stored in a format.
11. The <ESC>R Rotate command can be used.
12. The print height of the symbol will vary depending upon the data specified; numeric only, alpha only or alphanumeric.

Printer Configuration Commands

The following commands are used to configure the operating parameters of the printer. They are in effect the “software Configuration DIP switches” for the CT Series printers.

Eurocharacter Select

Command Structure	<ESC>LD,a,b,c,d,e,f,g,h,i,j,
a	= Replacement character for STX in ASCII or hex format
b	= Replacement character for ETX in ASCII or hex format
c	= Replacement character for ESC in ASCII or hex format
d	= Replacement character for ENQ in ASCII or hex format
e	= Replacement character for CAN in ASCII or hex format
f	= Replacement character for NULL in ASCII or hex format
g	= Replacement character for OFFLINE in ASCII or hex format
h	= Auto-Online. Printer powers up in the On Line mode. 0 = Yes 1 = No
i	= Zero Slash. Places a slash through the "0" character. 0 = Yes 1 = No
j	= Eurocharacter select. Hexadecimal code for character to be replaced by the Eurocode character

Example: <ESC>LD,{,},%,#,&,*~,0,0,D5

Placement: Immediately following the <ESC>A Start command and in an independent data stream.

Default: Standard Protocol command Codes

Command Function Allows the user to defines custom Protocol Command codes.

Printer Input
<ESC>A
<ESC>LD,{,},%,#,&,*~,0,0
<ESC>Z

Printer Output A Protocol Command code status label will be printed as a result of the a successful download of a custom set of Protocol Command codes.

Special Notes

1. The parameter values can be left out if a change is not desired, however the commas must be present, i.e. to select D5H as the Eurocharacter without changing anything else, the command would be <ESC>LD,,, ,,,,5 (commas).

Not Implemented

Printer Setting

Command Structure <ESC>PGabcdehghijklmnopqrstuvwxyz

COMMAND PARAMETER	HEX VALUE	DESCRIPTION
a	00	Reserved
b	00	Reserved
c	00	Print Speed, 2 ips (50 mm/s)
	01	Print Speed, 3 ips (75 mm/s)
	02	Print Speed, 4 ips (100 mm/s)
	03	Print Speed, 5 ips (125 mm/s)
	04	Print Speed, 6 ips (150 mm/s)
d	00	Reserved
e	00	Cutter Mode, Backfeed after print
	01	Cutter Mode, Backfeed before print
	02	Cutter Mode, no Backfeed
f	00	Dispense Mode, Backfeed after print
	01	Dispense Mode, Backfeed before print
g	00	Reserved
h	41	Print Darkness Range A
	42	Print Darkness Range B
	43	Print Darkness Range C
	44	Print Darkness Range D
	45	Print Darkness Range E
	46	Print Darkness Range F
h	01	Print Darkness Level 1
	02	Print Darkness Level 2
	03	Print Darkness Level 3
	04	Print Darkness Level 4
	05	Print Darkness Level 5
i	00	Reflective (Eye-Mark) Sensor
	01	Transmissive (Gap) Sensor
	02	Sensors Disabled

COMMAND PARAMETER	HEX VALUE	DESCRIPTION
j	00	Zero Slash disabled
	01	Zero Slash enabled
k	00	Reserved
l	00	Paper Type, Labels
	01	Paper Type, Fan-Fold
m	00	Autofeed disabled
	01	Autofeed enabled
n	00	Pitch Fixed
	01	Pitch Proportional
o	000 to C80	Vertical Label Size (0 to 3200 dots)
p	000 to 340	Horizontal Label Size (0 to 832 dots)
q	000 to 792	Vertical Offset (0 to 792 dots)
	FFFF to FCE8	Vertical Offset (-1 to -792 dots)
r	000 to 792	Horizontal Offset (0 to 792 dots)
	FFFF to FCE8	Horizontal Offset (-1 to -792 dots)
s	00 to 63	Pitch Offset (0 to 99 dots)
t	00 to 63	Tear Off Offset (0 to 99 dots)
	FF to 9D	Tear Off Offset (-1 to -99 dots)
u	00 to 63	Cut Offset (0 to 99 dots)
	FF to 9D	Cut Offset (-1 to -99 dots)
v	00 to 63	DispenseOffset (0 to 99 dots)
	FF to 9D	Dispense Offset (-1 to -99 dots)
w	00	Reserved
x	00 to 40	Gap Size (0 to 64 dots)
y	00	Buzzer Enabled
	01	Buzzer Disabled

Placement: Separate data stream sent to printer

Default: None

Command Function To set the printer default configuration into EEPROM

Input to Printer <ESC>A
<ESC>PG
<ESC>Z

Printer Output There is no printer output as a result of this command.

Special Notes

1. All command parameter values must be in ASCII format.
2. These settings are stored in EEPROM and will remain valid until receipt of another <ESC>PG command.
3. All positions in this command must contain a valid setting.

Print Mode

Command Structure <ESC>PMa

a	=	0	Continuous
		1	Tear-Off
		2	Cut, Backfeed after print
		3	Cut, Backfeed before print
		4	Cut, no Backfeed
		5	Reserved
		6	Reserved
		7	Dispense, Backfeed after print
		8	Dispense, Backfeed before print

Example: See above

Placement: Separate data stream sent to printer

Default: Default value set by <ESC>PG command

Command Function To set the print mode for a job.

Input to Printer <ESC>A
 <ESC>PM1
 <ESC>Z

Printer Output There is no printer output as a result of this command.

Special Notes

1. When power is cycled, the value set by this command is lost and replaced by the default value stored in the EEPROM.
2. To change the value stored in the EEPROM, use the <ESC>PG Printer Setting command or use the Printer Setting Utility program contained on the CDROM shipped with the printer.

Print Type

Command Structure	<ESC>PHa a = 0 Thermal Transfer printing 1 Direct Thermal Printing Example: See above Placement: Separate data stream sent to printer Default: Default value set by <ESC>PG command.
Command Function	To set the printing method used for a job
Input to Printer	<ESC>A <ESC>PH1 <ESC>Z
Printer Output	There is no printer output as a result of this command.
Special Notes	<ol style="list-style-type: none">1. When power is cycled, the value set by this command is lost and replaced by the default value stored in the EEPROM.2. To change the value stored in the EEPROM, use the <ESC>PG Printer Setting command or use the Printer Setting Utility program contained on the CDROM shipped with the printer.

Pitch Offset

Command Structure <ESC>POabcc

a = 0 Cutter
 1 Dispense
 2 Tear-Off
 3 Continuous
b = + Positive Offset
 - Negative Offset
cc = 00 to 99, Offset value in dots

Example: See above

Placement: Separate data stream sent to printer

Default: Default value set by <ESC>PG command

Command Function To set the pitch offset used for a job.

Input to Printer <ESC>A
 <ESC>PO3+20
 <ESC>Z

Printer Output Blank label or tag

Special Notes

1. When power is cycled, the value set by this command is lost and replaced by the default value stored in the EEPROM.
2. To change the value stored in the EEPROM, use the <ESC>PG Printer Setting command or use the Printer Setting Utility program contained on the CDROM shipped with the printer.

Sensor Type

Command Structure	<ESC> IGa
	<pre>a = 0 Reflective (Eye Mark) sensor 1 See-thru (transmissive) sensor 2 Sensor not used</pre>
	Example: See above
	Placement: Separate data stream sent to printer
	Default: Default value set by <ESC>PG command
Command Function	To select the label sensing method for a job.
Input to Printer	<ESC>A <ESC> IG1 <ESC>Z
Printer Output	There is no printer output as a result of this command
Special Notes	<ol style="list-style-type: none"> 1. When power is cycled, the value set by this command is lost and replaced by the default value stored in the EEPROM. 2. To change the value stored in the EEPROM, use the <ESC>PG Printer Setting command or use the Printer Setting Utility program contained on the CDROM shipped with the printer.

Serial Interface Parameters

Command Structure <ESC>I2abcde

- a = 0 Baud rate, 9600 bps
- 1 Baud Rate, 19200 bps
- 2 Baud Rate, 38400 bps
- 3 Baud Rate, 57600 bps
- b = 0 8 Data bits
- 1 7 Data Bits
- c = 0 No Parity
- 1 Odd Parity
- 2 Even Parity
- d = 0 1 Stop Bit
- 1 2 Stop Bits
- e = 0 Single Item Buffer
- 1 Multi Item Buffer
- 2 X-On/X-Off Flow Control
- 3 Bi-Com 4
- 4 Bi-Com 3

Example: See above

Placement: Separate data stream sent to printer

Default: Default value set by <ESC>PG command

Command Function To set the operating parameters of the RS232 Interface for a job.

Input to Printer <ESC>
 <ESC>I230011
 <ESC>Z

Printer Output There is no printer output as a result of this command.

- Special Notes**
1. The settings are stored in the EEPROM by this command and they will remain in effect until a new <ESC>I2 command is received. Cycling power will have no effect on these settings.
 2. To change the value stored in the EEPROM, use the <ESC>PG Printer Setting command or use the Printer Setting Utility program contained on the CDROM shipped with the printer.
 3. All command parameters must be present in the data stream sent to the printer.
 4. Selecting X-On/X-Off, Bi-Com3 or Bi-Com4 will automatically place the printer in the Multi Buffer mode.

SECTION 5.

INTERFACE SPECIFICATIONS

INTRODUCTION

This section presents the interface specifications for the CT Series printers. These specifications include detailed information on how to properly interface your printer with your host system.

The following information is presented in this section:

- Interface Types
- Using the Receive Buffer
- IEEE 1284 Parallel Interface
- Universal Serial Bus (USB) Interface
- Local Area Network (LAN) Interface
- RS32C Serial Interface
 - General Specifications
 - Electrical Specifications
 - Pin Assignments
 - Ready/Busy Flow Control
 - X-On/X-Off Flow Control
 - Bi-Directional Communications Protocol
- Bi-Comm Communications Protocol
- Status Response

INTERFACE TYPES

The standard interface for the CT printers is a high speed, bi-directional parallel interface that conforms to the IEEE 1284 specification (ECP mode on some computers). The interface is also compatible with the older Centronics parallel interface standard. If it does not detect the correct IEEE 1284 signals in the interface connection, it will automatically operate in the standard Centronics mode which is much slower. To use the IEEE 1284 parallel interface to its fullest capability requires that the host also have an IEEE 1284 compatible interface and that the two be connected with a cable that meets the IEEE 1284 specification. If either of these two are not present, the data rate is severely compromised.

In order to provide flexibility in communicating with a variety of host computer systems all CT printers can be configured for operation with either an optional serial interface or an optional Universal Serial Bus (USB) interface. These optional interfaces are available as factory installed options only and must be specified at the time of order.

The Parallel interface will probably be the most useful in communicating with IBM PCs and compatibles. The RS232C Serial interface allows connectivity to a number of

other hosts. The USB interface allows the printer to be connected to a computer that supports peripherals attached to a USB bus. Up to 127 peripherals can be connected to a single USB port.

When using an optional interface, DSW-8 on the Configuration panel must be placed in the OFF position. When the IEEE 1284 interface is to be used, DSW-8 must be placed in the ON position.

WARNING: Never connect or disconnect interface cables (or use a switch box) with power applied to either the host or the printer. This may cause damage to the interface circuitry in the printer/host and is not covered by warranty.

THE RECEIVE BUFFER

The CT printers have the ability to receive a data stream from the host in one of two ways. The receive buffer may be configured to accept one print job at a time or multiple print jobs. The single job print buffer is generally used by software programs that wish to maintain control of the job print queue so that it can move a high priority job in front of ones of lesser importance. The multiple job buffer, on the other hand prints all jobs in the order they are received by the printer, and the order of printing

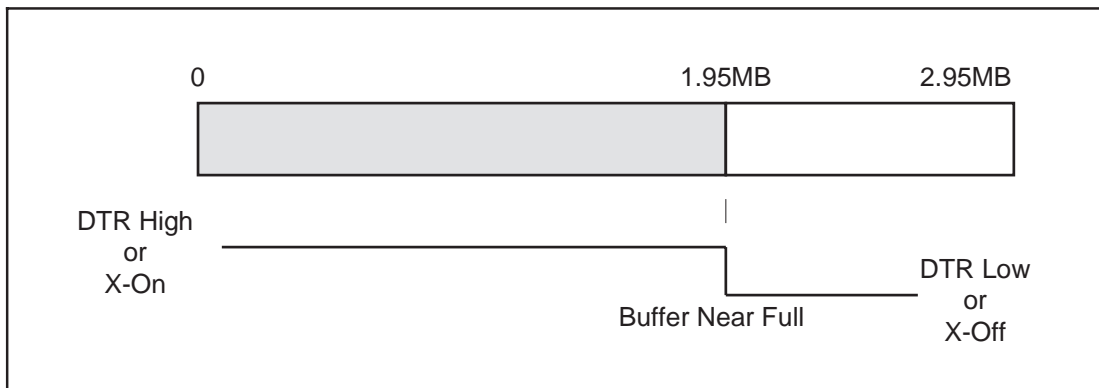

cannot be changed.

Single Job Buffer

The printer receives and prints one job at a time. Each job must not exceed 2.95MB.

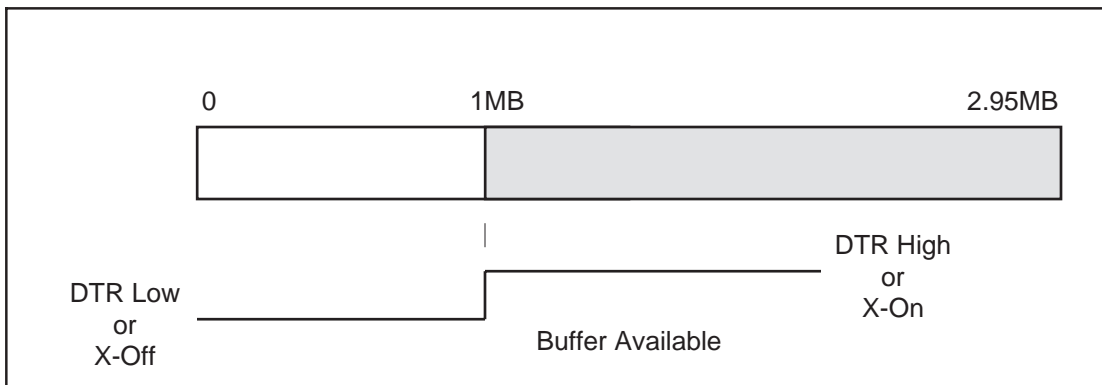

Multi Job Buffer

The printer is able to continuously receive print jobs, compiling and printing other jobs at the same time. It acts much like a “print buffer” to maximize the performance of the host and the printer.

When using the RS232 Serial interface, the Multi Job Buffer uses either the **Ready/Busy** with **DTR** (pin 20) or **X-On/X-Off** flow control protocols. See these sections for more details. With an empty receiving buffer, the status of **DTR** is “high” (or an **X-On** status if using **X-On/X-Off**), meaning the printer is ready to receive data. When the receive buffer is holding 1.95MB of data (1MB from being full), **DTR** will go “low” (or an **X-Off** is sent) indicating the printer can no longer receive data. This condition is called “Buffer Near Full.”

The receiving buffer will not be able to receive more data again until a “Buffer Available” condition occurs. This takes place when the receiving buffer has emptied so that only 1MB bytes of data are being held (1.95MB bytes from being full). At this time, **DTR** will go “high” or an **X-On** is sent to tell the host that it can again receive data.

All printer error conditions (i.e., label out, ribbon out) will cause the printer to go busy (**DTR** “low” or **X-Off**) until the problem is corrected and the printer is placed on-line. The printer will also be busy if taken off-line from the front panel.

IEEE 1284 PARALLEL INTERFACE

The parallel interface for the CT printers conforms to the IEEE 1284 specification. It will automatically detect the IEEE 1284 signals and operate in the high speed mode. If it does not detect the IEEE 1284 signals, it will operate in the standard Centronics mode, which is significantly slower. For this reason, an interface cable and host interface conforming to the IEEE 1284 specification must be present to fully utilize the speed capabilities. This interface also operates bi-directionally and can report the status of the printer back to the host.

DSW-8 on the Configuration Panel must be in the ON position to activate the parallel interface.

ELECTRICAL SPECIFICATIONS

Printer Connector	AMP 57-40360 (DDK) or equivalent
Cable Connector	AMP 57-30360 (DDK) or equivalent
Cable Length	10 ft. (3 m) or less
Signal Level	High = +2.4V to +5.0V Low = 0V to -0.4V

DATA STREAMS

<ESC>A . . Job#1 . . <ESC>Z<ESC>A . . Job#n . . <ESC>Z

IEEE 1284 Parallel Interface Pin Assignments

PIN	SIGNAL	DIRECTION	PIN	SIGNAL	DIRECTION
1	$\overline{\text{STROBE}}$	To Printer	19	STROBE Return	Reference
2	DATA 1	To Printer	20	DATA 1 Return	Reference
3	DATA 2	To Printer	21	DATA 2 Return	Reference
4	DATA 3	To Printer	22	DATA 3 Return	Reference
5	DATA 4	To Printer	23	DATA 4 Return	Reference
6	DATA 5	To Printer	24	DATA 5 Return	Reference
7	DATA 6	To Printer	25	DATA 6 Return	Reference
8	DATA 7	To Printer	26	DATA 7 Return	Reference
9	DATA 8	To Printer	27	DATA 8 Return	Reference
10	$\overline{\text{ACK}}$	To Host	28	ACK Return	Reference
11	BUSY	To Host	29	BUSY Return	Reference
12	PTR ERROR	To Host	30	PE Return	Reference
13	SELECT	To Host	31	$\overline{\text{INIT}}$	From Host
14	$\overline{\text{AUTOFD}}$ ⁽¹⁾	To Host	32	$\overline{\text{FAULT}}$	To Host
15	Not Used		33	Not Used	
16	Logic Gnd		34	Not Used	
17	FG	Frame Ground	35	Not Used	
18	+5V (Z=24K ohm)	To Host	36	$\overline{\text{SELECTIN}}$ ⁽¹⁾	From Host

(1) Signals required for IEEE 1284 mode.

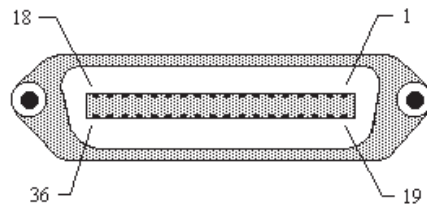

OPTIONAL RS232C SERIAL INTERFACE

The High Speed Serial Interface is an factory installed option that must be installed in the printer at the time of order. It is activated by placing DSW-8 on the Configuration Panel in the OFF position.

GENERAL SPECIFICATIONS

Asynchronous ASCII	Half-duplex communication
	Ready/Busy Hardware Flow Control Pin 20, DTR Control Pin 4, RTS Error Condition
	X-On/X-Off Software Flow Control
	Bi-Directional Communication
Data Transmission Rate	9600, 19200, 38400, 57600 bps
Character Format	1 Start Bit (fixed) 7 or 8 data bits (selectable) Odd, Even or No Parity (selectable) 1 or 2 Stop bits (selectable)

ELECTRICAL SPECIFICATIONS

Connector	DB-25S (Female)
Cable	DB-25P (Male), 50 ft. maximum length. For cable configuration, refer to Cable Requirements appropriate to the RS232C protocol chosen.
Signal Levels	High = +5V to +12V Low = -5V to -12V

PIN ASSIGNMENTS

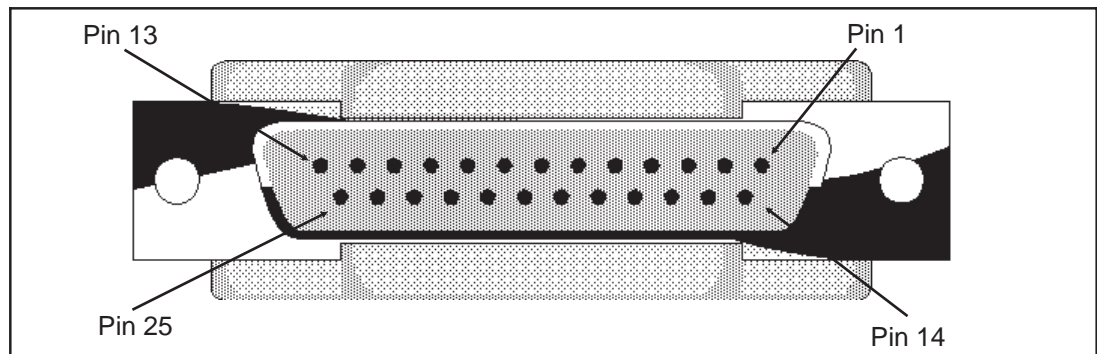

RS232C Interface Signals

PIN	DIRECTION	SIGNAL DEFINITION
1	Reference	FG (Frame Ground)
2	To Host	TD (Transmit Data) - Data from the printer to the host computer. Sends X-On/X-Off characters or status data (Bi-Directional protocols).
3	To Printer	RD (Receive Data) - Data to the printer from the host computer.
4	To Host	RTS (Request to Send) - Used with Ready/Busy flow control to indicate an error condition. RTS is high and remains high unless the print head is open (in this case, RTS would return to the high state after the print head is closed and the printer is placed back on-line) or an error condition occurs during printing (e.g., ribbon out, label out).
5	To Printer	CTS (Clear to Send) - When this line is high, the printer assumes that data is ready to be transmitted. The printer will not receive data when this line is low. If this line is not being used, it should be tied high (to pin 4).
6	To Printer	DSR (Data Set Ready) - When this line is high, the printer will be ready to receive data. This line must be high before data is transmitted. If this line is not being used, it should be tied high (to pin 20).
7	Reference	SG (Signal Ground)
20	To Host	DTR (Data Terminal Ready) - This signal applies to Ready/Busy flow control. The printer is ready to receive data when this pin is high. It goes low when the printer is off-line, either manually or due to an error condition, and while printing in the Single Job Buffer mode. It will also go low when the data in the buffer reaches the Buffer Near Full level.

Cable Requirements

DB9	DB25	HOST	INTERCONNECTION	PRINTER
1	1	FG	←————→	1 FG (Frame Ground)
2	3	RD	←————	2. TD (Transmit Data)
3	2	TD	————→	3 RD (Receive Data)
8	5	CTS	←————	4 RTS (Request to Send)
7	4	RTS	————→	5 CTS (Clear to Send)
4	20	DTR	————→	6 DSR (Data Set Ready)
6	6	DSR*	←————	20 DTR (Data Terminal Ready)
5	7	SG	←————→	7 SG (Signal Ground)

* This connection at the host side of the interface would depend upon the pin that is being used as the Ready/Busy signal by the driving software. Typically, on a PC, it would be either CTS (pin 5) or DSR (pin 6) on a DB-25 connector.

READY/BUSY FLOW CONTROL

Ready/Busy is the hardware flow control method for the serial interface on the CT printers. By raising/lowering the voltage level on Pin 20 of the RS232 port, the printer notifies the host when it is ready to receive data. Pin 4 (**RTS**) and pin 20 (**DTR**) are the important signals on the printer for this method of flow control. The

host must be capable of supporting this flow control method for it to function properly.

X-On/X-Off FLOW CONTROL

X-On/X-Off flow control is used whenever hardware (Ready/Busy) flow control is not available or desirable. Instead of a voltage going high/low at pin 20, control characters representing “Printer Ready” (**X-On** = 11 hexadecimal) or “Printer Busy” (**X-Off** = 13 hexadecimal) are transmitted by the printer on pin 2 (Transmit Data) to the host. In order for this method of flow control to function correctly, the host must be capable of supporting it. **X-On/X-Off** operates in a manner similar to the function of pin 20 (**DTR**) as previously explained. When the printer is first powered on it sends an **X-Off** when the “Buffer Near Full” level is reached and a **X-On** when the data level of the buffer drops below the “Buffer Available” mark. When the printer is taken off-line manually, it transmits an **X-Off** indicating it cannot accept data. When it is placed back on line manually, it sends an **X-On**, indicating it is again available for receipt of data. If an error occurs during printing (paper out, ribbon out), the printer sends an **X-Off** as soon as an error condition is detected. When the error is cleared and the printer is placed back on-line, it transmits an **X-On** indicating it is again ready to accept data.

Upon power up if no error conditions are present, the printer will continually send **X-On** characters at five millisecond intervals until it receives a transmission from the host.

Data Streams

The data streams for **X-On/X-Off** and **Ready/Busy** flow control are constructed in the same way as they are for Ready/Busy flow control.

<ESC>A . . Job#1 . . <ESC>Z<ESC>A . . Job#n . . <ESC>Z

Example: <ESC>A . . Job#1 . . <ESC>Z

NOTE: All characters are in ASCII.

UNIVERSAL SERIAL BUS (USB) OPTIONAL INTERFACE

The Universal Serial Bus (USB) interface is a factory installed option that must be specified at the time of order. When it is installed, the printer can be configured to receive data through the IEEE 1284 parallel interface or the optional USB interface. It requires a driver (shipped with each printer that has the interface installed) that must be loaded on your PC and the PC must be configured to support USB peripherals using Windows 98. Details for loading the USB driver are contained in the USB Interface Manual that is shipped with each printer with a USB Optional interface installed. Up to 127 devices may be connected to a USB port.

LOCAL AREA NETWORK (LAN) OPTIONAL INTERFACE

A Local Area Network (LAN) interface is a factory installed interface option that must be specified at the time of order. When it is installed, the printer can be configured to receive data through the IEEE 1284 parallel interface or the optional LAN interface. It requires a driver (shipped with each printer that has the interface installed) that must be loaded on your PC and the PC must be configured to support the TCP/IP network protocol using a 10BaseT LAN connection. Details for loading the LAN driver are contained in the LAN Interface Manual that is shipped with each printer with a LAN Optional interface installed.

BI-DIRECTIONAL COMMUNICATIONS

This is a two-way communications protocol between the host computer and the printer, thus enabling the host to check printer status. When Bi-Com communications is selected, there is no busy signal from the printer. The host must request the complete status from the printer, including ready/busy. The host may request status in two different ways.

ENQUIRE/ACK/NAK

In the first mode, it transmits an **ENQ** (05 hexadecimal) to the printer and the printer will respond with its status within five milliseconds. If printing, it will respond upon finishing the current label, then resume printing. In order for this protocol to work properly with an RS232 Optional Interface, pin 6 (**DTR**) and pin 5 (**CTS**) must be held high by the host. One way to ensure these pins are always in the correct state is to tie pin 20 (**DTR**) to pin 6 (**DSR**) and pin 4 (**RTS**) to pin 5 (**CTS**) at the printer end of the cable.

Enquire (ENQ)

Upon receipt of an **ENQ** command, the printer responds with 25 bytes of status information bounded by an **STX/ETX** pair. The Bi-Com protocol works only in the Multi Job Buffer mode. The status information is defined as follows:

<STX>{ 2 Byte ID}{1 Status Byte}{6 Byte Label Remaining}{16 Byte Job Name}<ETX>

ID - This is a two byte number identifying the current print job ID. The print job ID is defined using the **<ESC>ID** Job ID command transmitted with the print job (see Job ID Store in the command listing for more information on how to use this command). The range is from 00 to 99.

Status - A single byte defining the current status of the printer (see the Status Byte Definition table).

Label Remaining - Six bytes defining the number of labels remaining in the current print job. The range is from 000000 to 999999 labels.

Job Name - 16 bytes of ASCII characters identifying the name assigned to the job by the **<ESC>WK Job Name** command. If the Job Name is less than 16 characters, the field will be padded with leading zeroes.

If an **ENQ** is received after the print job specified in the ID bytes has been completed, or there is no data in the buffer, the printer will respond with two “space” characters (20 hexadecimal) for the ID number, six “zero” characters (30 hexadecimal) in the Remaining Labels bytes and the 16 byte Job Name.

Cancel (CAN)

If a **CAN** (18 hexadecimal) command is received, it will stop the print job and clear all data from the receive and print buffers. A delay of five milliseconds or more is required before any new data can be downloaded. The **CAN** command is effective immediately upon receipt, even if the printer is off-line or in an error condition. The printer will return an **ACK** (06 hexadecimal) if there is no printer error condition and a **NAK** (15 hexadecimal) if an error condition exists.

Print Job

Upon receipt of a valid print job (<**ESC**>**A** . . . <**ESC**>**Z**), an **ACK** (06 hexadecimal) will be returned by the printer if there are no errors and a **NAK** (16 hexadecimal) if a printer error exists.

Print Stop (DLE)

If a **DLE** (10 hexadecimal) is received by the printer, the print process is stopped and an **ACK** (06 hexadecimal) is returned if there are no errors and a **NAK** (16 hexadecimal) if a printer error exists.

Print Start (DC1)

If the printer has been stopped by receipt of a **DLE** (10 hexadecimal) command, it can be restarted by sending a **DC1** (hexadecimal 11) command. Upon receipt of this command an **ACK** (06 hexadecimal) is returned if there are no errors and a **NAK** (16 hexadecimal) if a printer error exists.

(1) To provide compatibility with older SATO printers, the RS232 interface can be configured to use an earlier ENQ/ACK/NAK protocol. The earlier protocol did not have provisions for the Job Name and did not respond to the DLE or DC1 commands. Also, there are additional Response Codes in the Status Byte Definition. It is recommended that you use the current protocol rather than the earlier version unless it is necessary for compatibility with existing software.

Status Byte Definition, Bi-Com Protocol

ASCII	HEX	DEFINITION
OFF-LINE		
0	30	No Errors
1	31	Ribbon Near End
2	32	Buffer Near Full
3	33	Ribbon Near End and Buffer Near Full
4 ⁽¹⁾	34	Print Stop (no error)
ON-LINE, WAITING FOR DATA		
A	41	No Errors
B	42	Ribbon Near End
C	43	Buffer Near Full
D	44	Ribbon Near End and Buffer Near Full
E ⁽¹⁾	45	Print Stop (without error)
ON-LINE, PRINTING		
G	47	No Errors
H	48	Ribbon Near End
I	49	Buffer Near Full
J	4A	Ribbon Near End and Buffer Near Full
K ⁽¹⁾	4B	Print Stop (without error)
ON-LINE, WAITING TO DISPENSE A LABEL		
M	4D	No Errors
N	4E	Ribbon Near End
O	4F	Buffer Near Full
P	50	Ribbon Near End and Buffer Near Full
Q ⁽¹⁾	51	Print Stop (without error)
ON-LINE, COMPILING PRINT JOB		
S	53	No Errors
T	54	Ribbon Near End
U	55	Buffer Near Full
V ⁽¹⁾	56	Ribbon Near End and Buffer Near Full
W ⁽¹⁾	56	Print Stop (without error)
OFF-LINE, ERROR CONDITION		
b	62	Head Open
c	63	Paper End
d	64	Ribbon End
e	65	Media Error
f	66	Sensor Error
g	67	Head Error
j	6A	Cutter Error
k	6B	Other Error Condition

STATUS RESPONSE

The second method of determining printer status is to interrogate the printer with specific commands. The response from these commands will provide specific information about the printer status depending upon the command. This allows the controlling application to determine the status of a printer when it is located in a remote location.

Printer Status (SOH + MG)

Upon Receipt of an **SOH** (hexadecimal 01) followed immediately by an ASCII **MG** causes the printer to return a 30 byte Printer Status Word bounded by an **STX-ETX** pair that reports the current operating status of the printer.

BYTE NUMBER	HEX VALUE	DESCRIPTION
1	00	Thermal Transfer Print Type
	01	Direct Thermal Print Type
2	00	203 dpi Resolution
	01	305 dpi Resoution
3	00	2 ips Print Speed
	01	3 ips Print Speed
	02	4 ips Print Speed
	03	5 ips Print Speed
	04	6 ips Print Speed
4	00	Continuous Print Mode
	01	Tear-Off Print Mode
	02	Cutter Print Mode
	03	Label Dispense Print Mode
	04	Reserved
5	00	Cut at head position
	01	Cut at Cutter Position
	02	No back feed after cut
6	00	Dispense at head position
	01	Dispense at dispense position
7	00	Reserved
8	41	Print Density A
	42	Print Density B
	43	Print Density C
9	00	Print Density Level 1
	01	Print Density Level 2
	02	Print Density Level 3
	03	Print Density Level 4
	04	Print Density Level 5
10	00	Reflective (Eye-Mark) Sensor
	01	Gap (See-Thru) Sensor
	02	No Sensor

Section 5. Interface Specifications

BYTE NUMBER	HEX VALUE	DESCRIPTION
11	00 01	Zero Slash Disabled Zero Slash Enabled
12	00	Reserved
13	00 01	Label Media Tag Media
14	00 01	Default Feed Disabled Default Feed Enabled
15	00 01	Fixed Pitch Proportional Pitch
16-17	00 to C80 00 to 12C0	Vertical Label Size in dots (0 to 3200 for CT400) Vertical Label Size in dots (0 to 4800 for CT410)
18-19	00 to 340 00 to 4E0	Horizontal Label Size in dots (0 to 832 for CT400) Horizontal Label Size in dots (0 to 1248 for CT410)
20-21	00 to 3E7 FFFF to FC19	Vertical Base Reference Point Offset in dots (0 to 792) Vertical Base Reference Point Offset in dots (-1 to -792)
22-23	00 to 320 00 to FCE0	Horizontal Base Reference Point Offset in dots (0 to 800) Horizontal Base Reference Point Offset in dots (-1 to -800)
24	00 to 63 FF to 9D	Paper Pitch Offset in dots (0 to 99) Paper Pitch Offset in dots (-1 to -99)
25	00 to 63 FF to 9D	Tear-Off Offset in dots (0 to 99) Tear-Off Offset in dots (-1 to -99)
26	00 to 63 FF to 9D	Cut Offset in dots (0 to 99) Cut Offset in dots (-1 to -99)
27	00 to 63 FF to 9D	Dispense Offset in dots (0 to 99) Dispense Offset in dots (-1 to -99)
28	00 01	Compatibility Mode Enabled Compatibility Mode Disabled
29	08 to 40	Label Gap Size in dots (8 to 64)
30	00 01	Buzzer Enabled Buzzer Disabled

Counter Status (SOH + ME)

Upon Receipt of an **SOH** (hexadecimal 01) followed immediately by an **ME** (hexadecimal 4D45) causes the printer to return a 28 byte Head Counter Status Word bounded by an **STX-ETX** pair that reports the current status of the printer life counters.

BYTE NUMBER	VALUE	DESCRIPTION
1-8	Binary	Current Life Counter in dots
9-12	Binary	1st (Current) Head Counter in dots
13-16	Binary	2nd (Previous) Head Counter in dots
17-20	Binary	3rd Head Counter in dots
21-24	Binary	Cuttrrent Cut Counter in dots
25-28	Binary	Current Dispense Counter in dots

Sensor Status (SOH + SG)

Upon Receipt of an **SOH** (hexadecimal 01) followed immediately by an **SG** (hexadecimal 5347) causes the printer to return a 4 byte Sensor Status Word bounded by an **STX-ETX** pair that reports the values of the printer counters.

BYTE NUMBER	VALUE	DESCRIPTION
1	Binary	See-Thru Sensor Level (0 to 255)
2	Binary	Transmissive Sensor Level (0 to 255)
3	00H 01H	Out of Paper Paper Present
4	00H 01H	Head Open Head Closed

Head Status (SOH + HC)

Upon Receipt of an **SOH** (hexadecimal 01) followed immediately by an **HC** (hexadecimal 4843) causes the printer to return a 1 byte Head Fault Status Word bounded by an **STX-ETX** pair that reports the current operating status of the print head. Before the printer will respond to this command, it must be in the Download Mode (DSW1 = Off, DSW2 and DSW3 = On)

BYTE NUMBER	HEX VALUE	DESCRIPTION
1	00 01	Print Head OK Electrical Fault in Print Head

System Version Information

Upon Receipt of an **SOH** (hexadecimal 01) followed immediately by an **SB** (hexadecimal 4D47) causes the printer to return a 50 byte Printer Status Word bounded by an **STX-ETX** pair that reports the system version of the printer.

BYTE NUMBER	VALUE	DESCRIPTION
1-50	ASCII	Firmware Version Information

Memory Status

Upon Receipt of an **SOH** (hexadecimal 01) followed immediately by an **EB** (hexadecimal 4542) causes the printer to return a 24 byte Memory Status Word bounded by an **STX-ETX** pair that reports the current user memory allocation.

BYTE NUMBER	VALUE	DESCRIPTION
1-4	Binary	Free Font Memory
5-8	Binary	Total Font Memory
9-12	Binary	Free Form Overlay Memory
13-16	Binary	Total Form Overlay Memory
17-20	Binary	Free Graphic Memory
21-24	Binary	Total Graphic Memory

Form Overlay Status (SOH + FO)

Upon Receipt of an **SOH** (hexadecimal 01) followed immediately by an **FO** (hexadecimal 464F) causes the printer to return a 18 byte Form Overlay Status Word bounded by an **STX-ETX** pair that reports the Forms downloaded into the printer.

BYTE NUMBER	VALUE	DESCRIPTION
1-2	01 to 09	Form Registration Number (ASCII value)
3-18	ASCII	Form Name

Font Configuration (SOH + FG)

Upon Receipt of an **SOH** (hexadecimal 01) followed immediately by an **FG** (hexadecimal 4647) causes the printer to return a 102 byte Font/Graphics Status Word bounded by an **STX-ETX** pair that reports information on the stored font or graphic.

Note: The printer must be in the Font/Graphic Download (See Section 2: Configuration Switch) mode before a response will be received.

BYTE NUMBER	VALUE	DESCRIPTION
1-2	ASCII	Font ID Number
3-4	00H 01H	Font Graphic
5-36	ASCII	Font Name
37-48	ASCII	Font Style
49-52	ASCII	Font Point Size
53-54	Binary	Character Width in dots
54-60	Binary	Character Height in dots
57-60	Binary	Font Size
58-64	Binary	Font Registration Number
65-68	Binary	Font Data Top Address
69-72	Binary	Total Size
73-74	Binary	Vertical/Horizontal Writing Flag
75	Binary	Character Pitch, Fixed/Variable
76	Binary	Family Attribute
77	Binary	Character Set
78	Binary	Italic Attribute
79-80	Binary	Weight Attribute
81-82	Binary	Spread
83-84	Binary	Assent in dots
85-86	Binary	Registration Start Code
86-87	Binary	Registration End Code
88-95	Binary	Reserved
96-98	Binary	Code
99-100	Binary	Horizontal Valid Size
101-102	Binary	Left Gap Size

Interface Status

Upon Receipt of an **SOH** (hexadecimal 01) followed immediately by an **IG** (hexadecimal 4947) causes the printer to return a 1 byte Interface Status Word bounded by an **STX-ETX** pair that reports the type of interface connection currently set in the printer.

BYTE NUMBER	VALUE	DESCRIPTION
1	0	IEEE 1284 Parallel
	1	Serial RS232
	2	Local Area Network
	3	Universal Serial Bus

Serial Interface Settings

Upon Receipt of an **SOH** (hexadecimal 01) followed immediately by an **H2** (hexadecimal 4832) causes the printer to return a 5 byte Serial IF Status Word bounded by an **STX-ETX** pair that reports the current operating parameters of the Serial RS232 Interface.

BYTE NUMBER	VALUE	DESCRIPTION
1	0	9600 BPS
	1	19200 BPS
	2	38400 BPS
	3	57600 BPS
	4	115200 BPS (not currently available)
2	0	No Parity
	1	Odd Parity
	3	Even Parity
3	0	1 Stop Bit
	1	2 Stop Bits
4	0	Single Item Buffer with Ready/Busy Flow Control
	1	Multi-Item Buffer with Ready/Busy Flow Control
	2	X-ON/X-OFF Flow Control
	3	Status 4 Bi-Comm
	4	Status 3 Bi-Comm

SECTION 6.

TROUBLESHOOTING

This section has been devised to help you if you are unable to produce output on the CT Series printers. Use this section to make sure the basics have been checked before deciding you are unable to proceed any further. The section is divided into three parts:

- Initial Checklist
- Centronics Parallel Interface
- RS232C Serial Interface

INITIAL CHECKLIST

1. Is the printer powered up and ON-LINE?
2. Do any of the **Front Panel** LEDs indicate an error condition? If the Error LED is ON, it may mean the print head assembly is open.
3. Is the **Print Head** in the down and latched position.

USING THE IEEE 1284 PARALLEL INTERFACE

1. Is the IEEE 1284 printer cable connected securely to your parallel port (DB-25S Female) on the PC and to the Parallel Interface connector on the printer?

WARNING: Never connect or disconnect interface cables (or use a switch box) with power applied to either the printer or the host. This may cause damage to the interface circuitry and is not covered by warranty.

2. Does the Parallel interface cable used meet IEEE 1284 specifications?
3. Is there more than one parallel interface port on your PC (LPT1, LPT2, etc.)? If so, make sure you are sending data out the correct port.
4. Is the IEEE 1284 interface selected? DSW-8 must be in the OFF position to enable the Parallel interface.
5. When you send the print job to the printer, and it does not respond, do you get an error message on your PC that says "Device Fault" or something similar?

This may mean that the computer doesn't know the printer is there. Verify that:

- a. Both ends of the cable are securely inserted into their respective connectors.
 - b. The printer is ON-LINE.
 - c. The cable is not defective. There are other things that can cause this error message on your computer, but at this stage, a defective cable may be one of the reasons.
5. When you send the print job to the printer and it does not respond, and there is no error message on the PC:
- a. Check your data stream for some of the basics. Is your job framed as follows?

`<ESC>A—DATA—<ESC>Z`
 - b. Verify that you've included all required parameters in the data stream.
 - c. Verify the following:
 - You have not typed a "0" (zero) for an "O" (letter) or vice-versa.
 - You have not missed any <ESC> characters where they're needed.
 - Make sure all printer command codes are capital letters.
6. If you've checked all of the above and the printer still isn't printing, you may want to try a Buffer Hex Dump to determine what (if anything) the printer is receiving from your computer. See Printing Test Labels in Section 2.

The Parallel port is now listening for incoming data. Send your print job. The printer will now print (only once) a Hexadecimal (Hex) Dump of everything it received from the host computer. Each 2-digit hexadecimal character represents a character the printer received. It may be tedious, but now you can analyze and troubleshoot the data stream.

7. While checking the Hex Dump printout, if you notice 0D 0A (Carriage Return and Line Feed) characters throughout. The command string should be continuous and no CR or LF characters are allowed between the Start Command (**<ESC>A**) and the Stop Command (**<ESC>Z**). If you are using BASIC, it may be adding these characters automatically as the line wraps. Adding a "width" statement to your program can help to suppress these extra 0D 0A characters by expanding the line length up to 255 characters. See the beginning of Section 4: Command Codes for details on writing a program in BASIC.

If you're not programming in BASIC, check to see if you have an equivalent statement in the language you're using to suppress extra carriage returns and line feeds from your data being sent out to the printer. We want the data stream to be one complete line going to the printer.

USING THE RS232C SERIAL INTERFACE

1. Is the RS232C Serial cable connected securely to your serial port on the PC (DB- 25S or DB-9S Male) and to the RS232C connector on the printer?

WARNING: Never connect or disconnect interface cables (or use a switch box) with power applied to either the printer or the host. This may cause damage to the interface circuitry and is not covered by warranty.

2. Is the cable defective? At the very least, you should be using a “Null Modem Cable,” which crosses pins in a specific manner. This should enable your printer to print. But we recommend that you eventually use a cable built to specifications as described in Section 5: Interface Specifications.
3. Is the RS232 Interface option installed in the printer? DSW-8 must be in the ON position to enable the Optional Interface.
4. Check for obvious errors in the data stream. Is the data properly framed with the <ESC>A and <ESC>Z commands? See Section 5 if necessary.
5. If after sending your job to the printer, it only “beeps” and displays an error message of the 7-segment display, you may have a configuration problem. There may be some inconsistencies with the Baud Rate, Parity, Data Bits, or Stop Bits in relation to your host computer. If you are confused as to what the printer’s current RS232 settings are, print a self test label(see Section 2: Printing a Test Label). It will list all of the current printer configuration settings.
6. If you still are unable to get printer output, try the Hex Dump as described in Step 5 under the Centronics Interface troubleshooting. In this case, the printer monitors its RS232C interface for incoming data.
7. From the Hex Dump, if you are seeing extra 0D 0A (CR and LF) characters, and are using BASIC, refer to the beginning of the Command Code section. It provides hints for writing a SATO program in BASIC.

ERROR SIGNALS

The 7-segment LED display, Front Panel LED Indicators and Buzzer provide a visual/audio indication of the type of error encountered.

DIS-PLAY	LED INDICATORS		BUZZER	ERROR CONDITION	CORRECTIVE ACTION
	LINE	ERROR			
0		ON	1 Beep	Flash Memory error.	Replace Flash ROM
1				Not Assigned	
2		ON	1 Beep	Motherboard error	Replace PCB
3		ON	1 Beep	EEPROM error	Replace EEPROM
4		ON	1 Beep	Electrical Head error	Replace Print Head
5		Blink	3 Beeps	Head not latched	Latch Pprint Head
6		Blink	3 Beeps	Out of Paper	1) Replenish paper supply 2) Route paper thru sensor
7		Blink	3 Beeps	Sensor error	1) Select correct sensor 2) Adjust sensor level
8		Blink	3 Beeps	Cutter error	Connect cutter
8.	ON	ON		Program download error	Retry download
9		Blink	3 Beeps	Ribbon End (TT mode only)	1) replace ribbon
A	ON		1 Beep	Receive buffer overflow	1) Modify host SW 2) Select correct protocol
b	ON		1 Beep	Parity error (Serial I/F only)	Correct Parity Settings
c	ON		1 Beep	Framing error (Serial I/F only)	Correct data bit setting
d	ON		1 Beep	Overrun error (Serial I/F only)	Correct flow control settings
E	ON		1 Beep	LAN Time Out error	Replace LAN I/F
F			3 Beeps	Download Font/Graphic error	Correct data stream

APPENDIX A. COMMAND CODE QUICK REFERENCE

INSTRUCTION	DESCRIPTION	PAGE
-------------	-------------	------

A	Start Code. Begins all print jobs.	Page 4-70
----------	---	-----------

A1aaaabbbb	Media Size. Specifies the label size. Used to automatically calculate the offset for center justified labels.	Page 4-54
-------------------	---	-----------

	CT400	CT410
aaaa = Label Width	0832	1248
bbbb = Length	3200	4800

A3Habbbb Vcdddd	Base Reference Point. Establishes a new base reference point position in dots for the current label. Units of measurement are dots.	Page 4-17
----------------------------	--	-----------

- a = - Shifts horizontal reference point in negative direction.
- + Shifts horizontal reference point in positive direction.
- bbbb = Amount of horizontal shift in dots
- c = - Shifts vertical reference point in negative direction.
- + Shifts vertical reference point in positive direction.
- dddd = Amount of vertical shift in dots

	CL408	CL412
aaaa = Horizontal Print Offset	+/- 0832	+/- 1248
bbbb = Vertical Print Offset	+/- 3200	+/- 4800

INSTRUCTION	DESCRIPTION	PAGE
Babbcccd	<p>Bar Codes. Prints a 1:3 ratio bar code.</p> <ul style="list-style-type: none"> a = 0 Codabar 1 Code 39 2 Interleaved 2 of 5 (I 2/5) 3 UPC-A/EAN-13 4 EAN-8 5 Industrial 2 of 5 6 Matrix 2 of 5 7 reserved 8 reserved 9 reserved A MSI B reserved C Code 93 D reserved E UPC-E F Bookland G Code 128 I UCC 128 <ul style="list-style-type: none"> bb = Number of dots (01-12) for narrow bar and narrow space ccc = Bar height in dots (001-600) d = UCC 128 only <ul style="list-style-type: none"> 0 No human readable text 1 Human readable at top 2 Human readable at bottom 	Page 4-9
BDabbcccd	<p>Bar Codes. Prints a 2:5 ratio bar code, except for UPC, EAN, Code 93, Code 128 and UCC128 symbols, which are fixed width bar codes. For values a, bb, ccc and d see instructions for Babbcccd.</p> <p>For UPC/EAN bar codes, this command puts descender bars and human readable text below the symbol.</p>	Page 4-9
BKaabbccdd eeefffn...n,g	<p>PDF417. Prints PDF417 2-D symbols.</p> <ul style="list-style-type: none"> aa = Minimum module dimension (03-09 dots). Will not print for values of 01, 02 or ≥ 10. bb = Minimum module pitch dimension (04-240 dots). Will not print for values of 01, 02, 03 or greater than 25. c = Security level (1-8). dd = Code words per line (01-30). If 00 is specified for dd <i>and</i> ee, printer will automatically optimize settings. ee = Rows/symbol (00 or 03). If 00 is specified for dd <i>and</i> ee, printer will automatically optimize settings. fff = Number of characters to be encoded (0001-2700) nn...n = Data to be printed. g = Not present. Standard PDF <ul style="list-style-type: none"> = T Truncated PDF = M Micro PDF 	Page 4-79
BPn...n	<p>Postnet. Prints Postnet bar codes.</p> <ul style="list-style-type: none"> n...n = 5 digit ZIP (Postnet-32 format) 6 digits (Postnet-37 format) 9 digit ZIP+4 (Postnet -52 format) 11 digit ZIP+4+DPC (Postnet-62, Delivery Point format). 	Page 4-56

INSTRUCTION	DESCRIPTION	PAGE
BTabbccddee	<p>Bar Codes. Variable Ratio. provides the ability to print a bar code with a ratio other than those specified through the standard bar code commands (B, BD, and D).</p> <ul style="list-style-type: none"> a = Bar code option: <ul style="list-style-type: none"> 0 Codabar 1 Code 39 2 Interleaved 2 of 5 5 Industrial 2 of 5 6 Matrix 2 of 5 bb = Narrow space in dots (01-99) cc = Wide space in dots (01-99) dd = Narrow bar in dots (01-99) ee = Wide bar in dots (01-99) 	Page 4-15
BVa,b,c, dddddddd, eee, f f f, gg..g	<p>Maxicode. Prints 2-D Maxicode symbols per AIM I.S.S. specification.</p> <ul style="list-style-type: none"> a = Position of symbol within the set b = Total number of symbols in the set c = Mode dd..d = 9 digit numeric Postal Code eee = 3 digit numeric Country Code f f f = 3 digit numeric Service Class gg..g = Data, terminated by <ESC> 	Page 4-77
BWaabbb	<p>Bar Codes. Expansion. Works together with the BT command to specify an expansion factor and the bar code height for the particular symbol being printed.</p> <ul style="list-style-type: none"> aa = Expansion factor by which the width of all bars and spaces is increased (01-12) bbb = Bar height by dot (004-600 dots) 	Page 4-14
BXaabbccdd eeeffghh	<p>Data Matrix. Data Format. Specifies the format of the Data Matrix 2-D symbology.</p> <ul style="list-style-type: none"> aa = Format ID (01-06) bb = Error correction level (00, 05, 08, 10, 14 or 20) cc = Horizontal cell size (03-12 dots/cell) dd = Vertical cell size (03-12 dots per cell) eee = Cells per line. Must use 000 for optimized symbol. fff = Cell lines. Must use 000 to optimize. g = Mirror image <ul style="list-style-type: none"> 0 Normal Print 1 Reverse Print hh = Guide cell thickness (01-15) 01 indicates normal type. 	Page 4-72
C	<p>Repeat Label. Prints a duplicate of the last label printed.</p>	Page 4-62

INSTRUCTION	DESCRIPTION	PAGE
-------------	-------------	------

CSa **Print Speed Selection.** Specifies a unique print speed in in./sec. through software for a particular label. Page 4-61

	CT400	CT410
a = Speed Setting	1 = 2 ips 2 = 3 ips 3 = 4 ips 4 = 5 ips 5 = 6 ips	1 = 2 ips 2 = 3 ips 3 = 4 ips

CTaaaa **CUT.** Specifies the number of labels between cuts. Differs from “~” cut command in that the number of labels printed is independent of the Q quantity command. Page 4-32
 aaaa = Number of labels between cuts. (0 - 9999)

Dabbbccd **Bar Codes.** Prints 1:2 ratio bar code. For UPC and EAN bar codes, this will add descender bars. For values a, bb, ccc and d see instructions for Babbccd. Page 4-9

DCxx...x **Data Matrix.** Print Data. Prints data using Data Matrix format specified in BX Data Format command. Page 4-74
 xx...x = Data to be printed. Cannot exceed 500 characters.

Eaaa **Line Feed.** Provides the ability to print multiple lines of the same character size without specifying a new print position for each line. Page 4-52
 aaa = Number of dots (1-999) between the bottom of the characters on one line to the top of the characters on the next line.

**Faaaabcccc
ddee,f** **Sequential Numbering.** Allows the printing of sequencing fields (text, bar codes) where all incrementing is done within the printer. Page 4-68
 aaaa = Number of times to repeat the same data (0001-9999)
 b = Plus or minus symbol (+ for increments; - for decrements)
 cccc = Value of step for sequence (001-9999)
 dd = No. of digits for sequential numbering (01-99, default = 8)
 ee = No. of digits free from sequential numbering (01-99, default = 0)
 f = Numbering system
 0 Numeric (0 - 9)
 1 Hexadecimal (0 - F)

FWaaHbbbb **Horizontal Line.** Prints a horizontal line. Units of measurement are dots. Page 4-48

	CT400	CT410
aa = Width of Horizontal Line	01 to 99	
bbbb = Length of Horizontal Line	0001-0832	0001-1248

INSTRUCTION	DESCRIPTION	PAGE															
FWaabbVccc Hdddd	Box. Prints a box. For values aa, bbbb, cc, and dddd, see instructions for horizontal and vertical lines. Units of measurement are dots.	Page 4-48															
	<table border="1"> <thead> <tr> <th></th> <th>CT400</th> <th>CT410</th> </tr> </thead> <tbody> <tr> <td>aa = Width of Horizontal Side</td> <td colspan="2">01 to 99</td> </tr> <tr> <td>bb = Width of Vertical Side</td> <td colspan="2">01 to 99</td> </tr> <tr> <td>cccc = Length of Vertical Side</td> <td>0001-1424</td> <td>0001-2136</td> </tr> <tr> <td>dddd = Length of Horizontal Side</td> <td>0001-0832</td> <td>0001-1248</td> </tr> </tbody> </table>		CT400	CT410	aa = Width of Horizontal Side	01 to 99		bb = Width of Vertical Side	01 to 99		cccc = Length of Vertical Side	0001-1424	0001-2136	dddd = Length of Horizontal Side	0001-0832	0001-1248	
	CT400	CT410															
aa = Width of Horizontal Side	01 to 99																
bb = Width of Vertical Side	01 to 99																
cccc = Length of Vertical Side	0001-1424	0001-2136															
dddd = Length of Horizontal Side	0001-0832	0001-1248															
FWccVddd	Vertical Line. Prints a vertical line. Units of measurement are dots.	Page 4-48															
	<table border="1"> <thead> <tr> <th></th> <th>CT400</th> <th>CT410</th> </tr> </thead> <tbody> <tr> <td>cc = Width of Vertical Line</td> <td colspan="2">01 to 99</td> </tr> <tr> <td>dddd = Length of Vertical Line</td> <td>0001-3200</td> <td>0001-4800</td> </tr> </tbody> </table>		CT400	CT410	cc = Width of Vertical Line	01 to 99		dddd = Length of Vertical Line	0001-3200	0001-4800							
	CT400	CT410															
cc = Width of Vertical Line	01 to 99																
dddd = Length of Vertical Line	0001-3200	0001-4800															
FXaaabccc dddeee	Data Matrix. Sequential Numbering. Prints sequential numbered Data Matrix 2-D symbols. aaa = Number of duplicate labels (001-999) b = Increment or decrement + Increment - Decrement ccc = Increment/decrement steps (001-999) ddd = Sequential numbering start position (001-999). Referenced to left side. eee = Incremented data length (001-999). Measured from start position.	Page 4-75															
Gabbccc(data)	Custom Graphics. Allows the creation and printing of graphic images using a dot-addressable matrix. a = Specifies format of data stream to follow B Binary H Hexadecimal bbb = Number of horizontal 8 x 8 blocks (001-152) ccc = Number of vertical 8 x 8 blocks (001-178 or 001-356 for 14" label) data = Data to describe the graphic image	Page 4-44															
Haaaa	Horizontal Position. Specifies a field's horizontal location across the width of the label from the current base reference point. The units of measurement are dots.	Page 4-58															
	<table border="1"> <thead> <tr> <th></th> <th>CT400</th> <th>CT410</th> </tr> </thead> <tbody> <tr> <td>aaaa = New Horizontal Position</td> <td>0001-0832</td> <td>0001-1248</td> </tr> </tbody> </table>		CT400	CT410	aaaa = New Horizontal Position	0001-0832	0001-1248										
	CT400	CT410															
aaaa = New Horizontal Position	0001-0832	0001-1248															
IDaa	Store Job ID. Stores the Job ID number. aa = Job ID number assigned (01-99)	Page 4-46															

INSTRUCTION	DESCRIPTION	PAGE
IGa	Sensor Type. Selects sensor used for label indexing. a = 0 Reflective (Eye-Mark) Sensor 1 Transmissive (Gap) Sensor 2 No sensor	Page 4-89
I2abcde	Serial I/F Set. Sets operating parameters for optional serial interface. a = Baud rate select 0 9600 BPS 1 19200 BPS 2 38400 BPS 3 57600 BPS b = Data bit select 0 8 data bits 1 7 data bits c = Parity Select 0 No parity 1 Odd parity 2 Even parity d = Stop bit select 0 1 stop bit 1 2 stop bits e = Protocol select 0 Single Item buffer 1 Multi Item buffer 2 X-On/X-Off Flow Control 3 Bi-Com Status Protocol 4 Bi-Com Status Protocol 3. (Used only for software compatibility)	Page 4-90
J	Journal Print. Provides the ability to print text line by line. Fixed spacing between lines and characters.	Page 4-47
Kab90cc	Recall Custom Designed Characters. Recalls for printing a custom character stored by the Tabcc(data) command. a = 1 16 x 16 matrix 2 24 x 24 matrix b = Indicates the format that data stream was stored in B Binary H Hexadecimal bb = Memory location where the character was stored. Valid locations are 21 to 52 or "!" to "R" in hex values.	Page 4-19
Laabb	Character Expansion. Expands characters in both directions. aa = Multiple to expand horizontally (01-12) bb = Multiple to expand vertically (01-12)	Page 4-21
LDa,b,c,d,e,f,g,i	Protocol Code Select. Selects the hexadecimal protocol codes to be used. See Section 4: Programming Reference for details.	Page 4-82
M	Font type. Specifies the 13W x 20H dot matrix font (including descenders).	Page 4-34

INSTRUCTION	DESCRIPTION	PAGE						
OA	Font type. Specifies the OCR-A font with dot matrix.	Page 4-34						
	<table border="1"> <thead> <tr> <th></th> <th>CT400</th> <th>CT410</th> </tr> </thead> <tbody> <tr> <td>OA Font Matrix</td> <td>15W x 22H</td> <td>22W x 33H</td> </tr> </tbody> </table>		CT400	CT410	OA Font Matrix	15W x 22H	22W x 33H	
	CT400	CT410						
OA Font Matrix	15W x 22H	22W x 33H						
OB	Font type. Specifies the OCR-B font dot matrix.	Page 4-34						
	<table border="1"> <thead> <tr> <th></th> <th>CT400</th> <th>CT410</th> </tr> </thead> <tbody> <tr> <td>OB Font Matrix</td> <td>20 W x 24H</td> <td>30W x 36H</td> </tr> </tbody> </table>		CT400	CT410	OB Font Matrix	20 W x 24H	30W x 36H	
	CT400	CT410						
OB Font Matrix	20 W x 24H	30W x 36H						
Paa	Character Pitch. Designates the number of dots between characters.	Page 4-24						
	aa = Number of dots between characters (01-99)							
PGa.....z	Printer Setting. Sets the printer default operating parameters into EEPROM. See Section 4: Programming Reference for details.	Page 4-83						
PMa	Print Mode. Sets the Print Mode for the current job.	Page 4-86						
	a = 0 Continuous print 1 Tear-Off 2 Cut, Backfeed after print 3 Cut, Backfeed before print 4 Cut, no backfeed 5 Reserved 6 Reserved 7 Dispense, Backfeed after print 8 Dispense, Backfeed before print							
PHa	Print Type. Sets the Print Type for the current job.	Page 4-87						
	a = 0 Thermal transfer printing 1 Direct thermal printing							
P0	Pitch Offset. Sets the pitch offset to be used for the current job.	Page 4-88						
	a = 0 Use Cut offset 1 Use Dispense offset 2 Use Tear-off offset 3 Continuous print. b = + Positive offset - Negative offset cc = Offset value in dots (00 to 99)							
PR	Fixed Character Spacing. Returns the printer to fixed character spacing mode.	Page 4-23						
PS	Proportional Character Spacing. Places the printer in the proportional character spacing mode. Will not work with U Font.	Page 4-26						
Qaaaaa	Print Quantity. Specifies the total number of labels to print.	Page 4-60						
	aaaaa = Total number of labels to print for the job (000001-999999)							

INSTRUCTION	DESCRIPTION	PAGE						
RDabb,ccc,ddd, nn . . . n	Raster Font. Stored raster font select. a = A CG Times B CG Triumvirate bb = 00 Normal 01 Bold cccc = Horizontal size. (16 to 999 dots or P08 to P72 points) dddd = Vertical size. (16 to 999 dots or P08 to P72 points)	Page 4-37						
RFaabbbb,nn..n	Font/Graphic Recall. Recalls a stored font or graphic. aa = Font ID number (00 to 99) bbbb = Number of characters to print (0000 to 9999) nn..n = Data to be printed	Page 4-36						
S	Font type. Specifies the 8W x 15H dot matrix font (including descenders).	Page 4-34						
Tabcc(data)	Store Custom Designed Characters. To create and store custom characters or images in the printer's volatile memory. See Kab90cc to recall the character for printing. a = 1 16 x 16 matrix 2 24 x 24 matrix b = Specifies data stream format to follow B Binary H Hexadecimal cc = Memory location to store the character. Valid locations are 21 to 52 or "!" to "R" in hex values. (data)= Data to describe the character.	Page 4-19						
U	Font type. Specifies a 5W x 9L dot matrix font (including descenders).	Page 4-34						
Vbbbb	Vertical Position. Specifies a field's vertical location down the length of the label from the current base reference point. Units of measurement are dots.	Page 4-58						
<table border="1"> <thead> <tr> <th></th> <th>CT400</th> <th>CT412</th> </tr> </thead> <tbody> <tr> <td>bbbb = New Vertical Position</td> <td>0001-3200</td> <td>0001-4800</td> </tr> </tbody> </table>				CT400	CT412	bbbb = New Vertical Position	0001-3200	0001-4800
	CT400	CT412						
bbbb = New Vertical Position	0001-3200	0001-4800						
WBa	Font type. Specifies the 18W x 30L dot matrix font (including descenders). a = 0 Disables auto-smoothing of font 1 Enables auto-smoothing if expansion is greater than 3	Page 4-40						
WDHaaaaVbbbb XccccYdddd	Copy Image Area. To copy an image to another location of the label. aaaa = Horizontal position of the top left corner of image area bbbb = Vertical position of the top left corner of image area cccc = Horizontal length of image area dddd = Vertical length of image area	Page 4-29						
WKnn . . n	Job Name. ASCII characters identifying the job name. nn...n = Up to 16 ASCII characters	Page 4-50						

INSTRUCTION	DESCRIPTION	PAGE
WLa	Font type. Specifies the 28W x 52L dot matrix font (including descenders). a = 0 Disables auto-smoothing of font 1 Enables auto-smoothing if expansion is greater than 3	Page 4-40
XM	Font type. Specifies the 24W x 24H dot matrix font (including descenders).	Page 4-34
XS	Font type. Specifies the 17W x 17H dot matrix font (including descenders).	Page 4-34
XU	Font type. Specifies the 5W x 9L dot matrix font (including descenders).	Page 4-34
XLa	Font type. Specifies the 48W x 48L dot matrix font (including descenders). a = 0 Disables auto-smoothing of font 1 Enables auto-smoothing if expansion is greater than 3	Page 4-40
XBa	Font type. Specifies the 48W x 48L dot matrix font (including descenders). a = 0 Disables auto-smoothing of font 1 Enables auto-smoothing if expansion is greater than 3	Page 4-40
YC	Cut Last. Cuts last printed label and retracts head to print position.	Page 4-33
YEa	Label/Tag Select. Selects the operation of the “Paper Out” signal. a = 0 Label selection. Print tops upon detection of Paper Out. 1 Tag selection. Print stops after label is printed.	Page 4-51
Z	Stop Code. Ends all print jobs.	Page 4-70
%a	Rotate. Fixed Base Reference Point. Rotates printing in 90° increments without changing the base reference point. a = 0 Sets print to normal direction 1 Sets print to 90° CCW 2 Sets print to 180° rotated (upside down) 3 Sets print to 270° CCW (90° CW)	Page 4-67

INSTRUCTION	DESCRIPTION	PAGE									
\$a,b,c,d	<p>Vector font. Specifies printing of the unique SATO vector font.</p> <ul style="list-style-type: none"> a = A Helvetica Bold (proportional spacing) B Helvetica Bold (fixed spacing) b = Font width (50-999 dots*) c = Font height (50-999 dots*) d = Font variation (0-9) as follows: <ul style="list-style-type: none"> 0 Standard 1 Standard open (outlined) 2 Gray (mesh) pattern 1 3 Gray (mesh) pattern 2 4 Gray (mesh) pattern 3 5 Standard, shadow 1 6 Standard, shadow 2 7 Standard mirror image 8 Italic 9 Italic open (outlined) 	Page 4-38									
\$(data)	Data for Vector font.	Page 4-38									
#Eab	<p>Print Darkness. Specifies a new print darkness setting.</p> <ul style="list-style-type: none"> a = Print Darkness Range (A to F) b = Print Darkness Level (1 to 5) 	Page 4-57									
(aaaa,bbbb	<p>Reverse Image. Reverse image from black to white and vice versa. Units of measure are dots.</p> <table border="1" data-bbox="381 1073 1240 1205"> <thead> <tr> <th></th> <th>CT400</th> <th>CT410</th> </tr> </thead> <tbody> <tr> <td>aaaa = Horizontal Length</td> <td>0001-0832</td> <td>0001-1248</td> </tr> <tr> <td>bbbb = Vertical Length</td> <td>0001-3200</td> <td>0001-4800</td> </tr> </tbody> </table>		CT400	CT410	aaaa = Horizontal Length	0001-0832	0001-1248	bbbb = Vertical Length	0001-3200	0001-4800	Page 4-65
	CT400	CT410									
aaaa = Horizontal Length	0001-0832	0001-1248									
bbbb = Vertical Length	0001-3200	0001-4800									
&	Store Form Overlay. Stores a specified label image in the printer's volatile form overlay memory.	Page 4-43									
/	Recall Form Overlay. Recalls the label image from the printer's form overlay memory for printing.	Page 4-42									
0 (zero)	Replace Data (Partial Edit). Provides the ability to replace a specified area of the previous label with new data.	Page 4-63									
*a	<p>Clear Print Job(s) and Memory. Clears individual memory and buffers.</p> <ul style="list-style-type: none"> a = When not included in command, clears print jobs in Multi-Buffer mode. a = If included in command, specifies memory section to be cleared <ul style="list-style-type: none"> T Custom character memory, printer & Form overlay memory, printer X Clears all memory all memory and buffers 	Page 4-27									
@	Off-Line. Signals the printer to go off-line after the completion of a print job.	Page 4-55									

<NUL>aaaa
~aaaa

Cut Job. Controls the cutting of labels when using the optional SATO cutter unit. Either a <NUL> or tilde character can be used in this command.
aaaa = Number of labels to print between each cut (0000-9999)

Page 4-31

This page left intentionally blank.

APPENDIX B.

BAR CODE SPECIFICATIONS

BAR CODE SYMBOLOGIES

This section contains detailed information on the printing of bar codes on the CT Series printers. Information on printing the following bar code symbologies is provided:

- Codabar
- Code 39
- Interleaved 2 of 5
- UPC-A/EAN-13
- EAN-8
- Industrial 2 of 5
- Matrix 2 of 5
- Code 128
- MSI
- Code 93
- UPC-E
- UPC Supplements(Bookland)
- UCC-128
- Postnet
- Data Matrix
- Maxicode
- PDF417

Codabar

Command Structure

1:3 ratio <ESC>B0bbcccd (data) d
 2:5 ratio <ESC>BD0bbcccd (data) d
 1:2 ratio <ESC>D0bbcccd (data) d

bb = Width of narrow element in dots (01-12)
 ccc = Bar height in dots (001-600)
 d = Required Start and Stop character (A, B, C, or D)
 (data) = Bar code data (alphanumeric)

Character Set

0-9, -, \$, :, /, +
 A, B, C, D (Start/Stop characters)

Density Table

Printer Model	Narrow/Wide Ratio	Value of "bb"	"X" Dimension (mils)	Density (char/inch)
CT410	1:3	01	3.3	25.0
	1:3	02	6.7	12.6
	2:5	01	6.7	13.6
	1:2	02	3.3	15.1
CT400	1:3	01	5.0	16.9
	1:3	02	10.0	8.5
	2:5	01	10.0	9.2
	1:2	02	5.0	10.2

Example

```
<ESC>H0400<ESC>V0025<ESC>B002100A12345B
<ESC>H0440<ESC>V0135<ESC>XS12345
```

Notes

You must add the appropriate (A, B, C or D) Start and Stop characters to the data string. The printer does not automatically add them when printing.



Code 39

Command Structure

1:3 ratio: <ESC>B1bbccc* (data) *
 2:5 ratio: <ESC>BD1bbccc* (data) *
 1:2 ratio: <ESC>D1bbccc* (data) *

bb = Width of narrow element in dots (01-12)
 ccc = Bar height in dots (001-600)
 * = Required Start and Stop character (asterisk)
 (data) = Bar code data (alphanumeric)

Character Set

0-9, A-Z, Space, \$, %, +, -, ., /
 * (Start/Stop character)

Density Table

Printer Model	Narrow/Wide Ratio	Value of "bb"	"X" Dimension (mils)	Density (char/inch)
CT410	1:3	01	3.3	18.8
	1:3	02	6.7	9.5
	2:5	01	6.7	10.3
	1:2	01	3.3	23.1
	1:2	02	6.7	11.5
CT400	1:3	01	5.0	12.7
	1:3	02	10.0	6.4
	2:5	01	10.0	7.0
	1:2	01	5.0	15.6
	1:2	02	10.0	7.8

Example

```
<ESC>H0100<ESC>V0025<ESC>B103100*CODE 39*
<ESC>H0230<ESC>V0130<ESC>XS*CODE 39*
```

Notes

You must add the "*" Start/Stop characters to the data stream. The printer does not add them automatically.



Interleaved Two of Five (I 2/5)

Command Structure

1:3 ratio: <ESC>**B2bbccc (data)**
 2:5 ratio: <ESC>**BD2bbccc (data)**
 1:2 ratio: <ESC>**D2bbccc (data)**

bb = Width of narrow element in dots (01-12)
 ccc = Bar height in dots (001-600)
 (data) = Bar code data (numeric); must be an even number of digits or else the printer will add a leading zero; start and stop code are provided by the printer

Character Set 0-9 (numeric only)

Density Table

Printer Model	Narrow/Wide Ratio	Value of "bb"	"X" Dimension (mils)	Density (char/inch)
CT410	1:3	01	3.3	33.4
	1:3	02	6.7	16.7
	2:5	01	6.7	18.8
	1:2	01	3.3	21.4
	1:2	02	6.7	14.3
CT400	1:3	01	5.0	22.6
	1:3	02	10.0	11.3
	2:5	01	10.0	12.7
	1:2	01	5.0	14.5
	1:2	02	10.0	9.7

Example

```
<ESC>H0100<ESC>V0100<ESC>B20310045676567
<ESC>H0140<ESC>V0210<ESC>XM4567 6567
```

Notes

To add horizontal guard bars to the top and bottom of the bar code, use the Line and Box command.



UPC-A/EAN-13

Command Structure <ESC>**B3bbccc (data)**
 <ESC>**D3bbccc (data)**
 <ESC>**BD3bbccc (data)**

bb = Width of narrow element in dots (01-12)

ccc = Bar height in dots (001-600)

(data) = Bar code data (numeric); must be exactly 13 digits. For
 UPC-A, the first digit must be a zero and the last 11 digits
 are the actual UPC-A data followed by a check digit.

To select UPC-A, 11 digits of data is sent. The printer adds a "0" and automatically generates the check digit. If 12 digits of data are sent, the printer assumes an EAN-13 symbol and automatically generates the check digit. The last digit of the bar code data is a modulo 10 check digit. If 13 digits of data are sent to the printer, the check digit is not created and must be supplied by the programmer. It must be the last character in the 13 digit string and can be determined by using the calculations outlined below.

Character Set 0-9 (numeric only)

Density Table

Printer Model	Value of "bb"	Narrow Bar Width (mils)	Magnification Factor
CT410	02	6.7	Below Minimum
	03	10.0	75%
	04	13.3	100%
CT400	02	10.0	75%
	03	15.0	112%
	04	20.0	150%

Notes D3 provides guide bars that extend longer than the rest of the bar code. BD3 provides guide bars and the human readable text below the symbol.

Example <ESC>H0100<ESC>V0375<ESC>BD30215001234567890



Calculating the Mod 10 Check Digit

If you wish to encode the UPC-A data "01234567890", follow these steps to find the correct check digit.

ODD	0		2		4		6		8		0	
EVEN		1		3		5		7		9		CD

1. First add all the numbers in the ODD positions.
i.e., $0+2+4+6+8+0 = 20$
2. Multiply the result of Step 1 by 3.
i.e., $20 \times 3 = 60$
3. Add up all the numbers in the EVEN positions.
i.e., $1+3+5+7+9 = 25$
4. Add the result of Step 2 to that of Step 3.
i.e., $60 + 25 = 85$
5. Subtract the result of Step 4 from the next highest increment of 10.
i.e., $90 - 85 = 5$
6. The correct Modulo 10 check digit for the 11 digit string "01234567890" is 5.

EAN-8

Command Structure <ESC>**B4bbccc (data)**
 <ESC>**D4bbccc (data)**

bb = Width of narrow element in dots (01-03)
ccc = Bar height in dots (001-600)
(data) = Bar code data (numeric); must be exactly 8 digits.

Character Set 0-9 (numeric only)

Density Table

Printer Model	Value of "bb"	Narrow Bar Width (mils)	Magnification Factor
CT410	02	6.7	Below Minimum
	03	10.0	75%
	04	13.3	100%
CT400	02	10.0	75%
	03	15.0	112%
	04	20.0	150%

Notes

1. D4 provides guide bars that extend longer than the rest of the bar code and the human readable text below the symbol.
2. The check digit is automatically calculated for EAN-8.

Example

<ESC>H0400<ESC>V0375<ESC>BD4031001234567



Industrial Two of Five

Command Structure 1:3 ratio: **B5bbccc (data)**
 2:5 ratio: **BD5bbccc (data)**
 1:2 ratio: **D5bbccc (data)**

bb = Width of narrow element in dots (01-12)
ccc = Bar height in dots (001-600)
(data) = Bar code data (numeric); must be an even number of digits or
 else the printer will add a leading zero

Character Set 0-9 (numeric only)

Notes To add horizontal guard bars to the top and bottom of the bar code,
 use the Line and Box command.

Example <ESC>H0100<ESC>V0600<ESC>BD50310012345
 <ESC>H0300<ESC>V0710<ESC>XS12345



Matrix Two of Five

Command Structure

1:3 ratio: <ESC>**B6bbccc (data)**
2:5 ratio: <ESC>**BD6bbccc (data)**
1:2 ratio: <ESC>**D6bbccc (data)**

bb = Width of narrow element in dots (01-12)
ccc = bar height in dots (001-600)
(data) = Bar code data (numeric only); must be an even number of digits or else the printer will add a leading zero.

Character Set 0-9 (numeric only)

Notes To add horizontal guard bars to the top and bottom of the bar code, use the Line and Box command.

Example

```
<ESC>H0100<ESC>V0775<ESC>BD60310012345  
<ESC>H0230<ESC>V0885<ESC>XS12345
```



Code 128

Command Structure <ESC>**BGbbccdd (data)**

- bb = Width of narrow element in dots (01-12)
- ccc = Bar height in dots (001-600)
- dd = Start code to specify initial subset of bar code data
 - >G Subset A Start code
 - >H Subset B Start code
 - >I Subset C Start code
- (data) = Includes bar code data and subset Shift codes; Shift codes are used to change the subset type within the bar code data.
 - Shift codes:
 - >E Subset A Shift code
 - >D Subset B Shift code
 - >C Subset C Shift code

Character Set See Code 128 Character Table on Page B-18

Density Table

Printer Model	Value of "bb"	"X" Dimension (mils)	Density (char/inch)	
			Subsets A, B	Subset C
CT410	01	3.3	27.3	54.7
	02	6.7	13.6	27.2
	03	10	9.1	18.3
CT400	01	5.0	18.2	36.5
	01	10.0	9.1	18.3
	03	15.0	13.8	12.2

Example The following will start in Subset A for the characters "AB", shift to Subset B for "789", then shift to Subset C for "123456".

```
<ESC>H0200<ESC>V0550<ESC>BG03100>GAB>B789>C123456
<ESC>H0310<ESC>V655<ESC>XSAB789123456
```



MSI

Command Structure

1:3 ratio: <ESC>**B**Abbccc (data) d
2:5 ratio <ESC>**BD**Abbccc (data) d
1:2 ratio <ESC>**D**Abbccc (data) d

bb = Width of narrow element in dots (01-12)
ccc = Bar height in dots (001-600)
(data) = Bar code data (numeric); maximum of 15 digits
d = Required check digit

Character Set 0-9 (numeric only)

Example

<ESC>H0100<ESC>V0950<ESC>BA03100123455
<ESC>H0170<ESC>V1060<ESC>XS12345



Code 93

Command Structure 1:3 ratio: <ESC>BC**bbcccdd** (data)

bb = Width of narrow element in dots (01-12)
ccc = Bar height in dots (001-600)
dd = Length of data (number of digits, 00-99)
(data) = Bar code data (alphanumeric); length must match value of
parameter "dd"; check digit is supplied by printer

Character Set 0-9, A-Z, -, ., Space, \$, /, +, %

Density Table

Printer Model	Narrow/Wide Ratio	Value of "bb"	"X" Dimension (mils)	Density (char/inch)
CT410	1:3	01	3.3	33.3
	1:3	02	6.7	16.7
	1:3	03	10	11.1
CT400	1:3	01	5.0	22.5
	1:3	02	10.0	11.3
	1:3	03	15	7.5

Example

<ESC>H0100<ESC>V1125<ESC>BC03100081234ABCD
<ESC>H0155<ESC>V1240<ESC>XS1 234ABCD



1234ABCD

UPC-E

Command Structure <ESC>**BE**bbccc (data)
 <ESC>**DE**bbccc (data)

bb = Width of narrow element in dots (01-03)
 ccc = Bar height in dots (001-600)
 (data) = Bar code data (numeric); must be exactly 6 digits

Character Set 0-9 (numeric only)

Density Table

Printer Model	Value of "bb"	Narrow Bar Width (mils)	Magnification Factor
CT410	02	6.7	Below Minimum
	03	10.0	75%
	04	13.3	100%
CT400	02	10.0	75%
	03	15.0	112%
	04	20.0	150%

Notes Command **DE** provides guide bars that extend longer than the rest of the bar code.

Example <ESC>H0400<ESC>V0550<ESC>DE03100123456
 <ESC>H0375<ESC>V0600<ESC>OB0
 <ESC>H0408<ESC>V0655<ESC>OB123456



Bookland (UPC/EAN Supplements)

Command Structure <ESC>BF**bbccc** (data)

- bb = Width of narrow element in dots (01-03)
- ccc = Bar height in dots (001-600)
- (data) = Bar code data (numeric); must be exactly 2 or 5 digits

Character Set 0-9 (numeric only)

Density Table

Printer Model	Value of "bb"	Narrow Bar Width (mils)	Magnification Factor
CT410	02	6.7	Below Minimum
	03	10.0	75%
	04	13.3	100%
CT400	02	10.0	75%
	03	15.0	112%
	04	20.0	150%

Example

```
<ESC>H0325<ESC>V0725<ESC>D30315009827721123
<ESC>L0101<ESC>H0295<ESC>V0800<ESC>OB0
<ESC>H0340<ESC>V0878<ESC>OB98277
<ESC>H 0480<ESC>V0878<ESC>OB21123
<ESC>H640<ESC>V0760<ESC>BF0313021826
<ESC>H655<ESC>V0730<ESC>OB21826
```



UCC-128

Command Structure <ESC>B**lbbcccd (data)**

- bb = Width of the narrow elements in dots (01 to 12)
ccc = Bar height in dots (001 to 600)
d = Placement of human readable text
0 None
1 Text at top of bar code
2 Text at bottom of bar code
(data) = 17 digits made up of the following:
1st digit = Container type
digits 2-8, Shipper identification
digits 9-17, Container Sequential number
Note: The Container Sequential number is not automatically sequenced by the printer.

Character Set See Code 128 Character Table on Page B-18

Density Table See Code 128, Page B-10

- Notes**
1. The Start, Function, Stop and Extension codes will be created by the printer and added automatically.
 2. The internal Modulo 10 check character will be automatically created and added by the printer. The overall Code 128 symbol check character will be automatically created by the printer and added.
 3. The automatically created human readable text will be created according to the following rules:
 - The spacing between the bar code and the text is fixed at 10 dots (.050 inches).
 - If the width of the human readable text is wider than the bar code, it will start at the same position as the bar code and extend past the right of the bar code.
 - If the width of the human readable text is less than the bar code, it will be centered on the bar code.
 - The automatically generated human readable font is OCR-B.
 - If any part of the human readable text extends outside the printable area, none of it will be printed. Care should be exercised when placing the bar code to allow for any automatically created human readable text.

Example

Without incrementing

```
<ESC>A  
<ESC>H0100<ESC>V0100<ESC>BI04150101234567000000001  
<ESC>Q2<ESC>Z
```



With incrementing

```
<ESC>A  
<ESC>H0100<ESC>V0100<ESC>F001+001  
<ESC>BI04150101234567000000001  
<ESC>Q2<ESC>Z
```



Postnet

Command Structure <ESC>BP (data)

data = 5 digits ZIP
 = 6 digits for Postnet 37
 = 9 digits for ZIP+4
 = 11 digits for Delivery Point Bar Code

Character Set 1-9 (numeric only)

- Notes**
1. Frame bits and check digits added automatically by printer.
 2. Bar code width and height are fixed and cannot be changed.
 3. If the number of digits sent to the printer as data does not match one of the formats specified above (i.e. 5, 6, 9 or 11), the command is ignored and nothing will be printed.
 4. If a “-” is included in the data stream (i.e. 84093-1565), it is ignored.

Example

```
<ESC>H0100<ESC>V0120<ESC>BP94089
<ESC>H0100<ESC>V0160<ESC>BP123456
<ESC>H0100<ESC>V0200<ESC>BP123456789
<ESC>H0100<ESC>V0240<ESC>BP12345678901
```

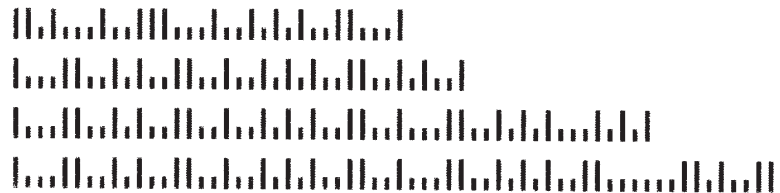

Data Matrix

Command Structure	Data Format	<ESC>BXaabbccddeeffghh
	aa	= Format ID. 01 to 06
	bb	= Error correction level. 00, 05, 08, 10, 14, Or 20.
	cc	= Horizontal cell size. 03 - 12 dots/cell.
	dd	= Vertical cell size. 03 - 12 dots/cell.
	eee	= Number of cells in one line. Must use 000 to optimize.
	fff	= Number of cell lines. Must use 000 to optimize.
	g	= Mirror Image
	0	= Normal Print
	1	= Reverse Print
	hh	= Guide Cell Thickness. 01-15. 01 indicates normal type.

Sequential Numbering <ESC>FXaaabccdddeee

aaa	=	Number of duplicate labels to be printed (001 - 999)
b	=	Increment or Decrement
	+	= Increment
	-	= Decrement
ccc	=	Increment/Decrement Steps (001 - 999)
ddd	=	Sequential numbering start position (001 - 999) Referenced to left side.
eee	=	Incremented data length measured from start position (001 - 999)

Print Data <ESC>DCxxx...x

xx...x = Data

Character Set

ID NUMBER	CHARACTER SET	ENCODING SCHEME
16 Bit CRC		
01	Numeric, Space	Base 11
02	Upper Case Alpha, Space	Base 27
03	Upper Case Alpha, Space, Comma, Period, Slash, Minus	Base 41
04	Upper Case Alphanumeric, Space	Base 37
05	ASCII 7-bit, Full Keyboard (20H - 7FH)	ASCII
06	ISO 8-bit, International (20H - FFH)	8-Bit

Notes

See AIM USA Technical Specification Data Matrix for information on the structure of this symbology.

Example

```
<ESC>V0100<ESC>H0100
<ESC>BX05051010000000001
<ESC>DCDATA MATRIX DATA MATRIX
```



Maxicode

Command Structure <ESC>BVa,b,c,ddddddddd,eee,fff,gggg.....<ESC>

- a = Position of Maxicode symbol within the set, when used in a structured append format 1~8.
- b = Total number of Maxicode symbols in the set, when used in a structured format 1~8.
- c = 2 For Mode 2 Structured Carrier Message for Domestic U.S. UPS shipments
 3 For Mode 3 Structured Carrier Message for International UPS shipments
 4 Standard symbol
 5 Not currently supported
 6 Reader programming
- ddd..ddd 9 digit numeric Postal Code
- eee = 3 digit numeric Country Code
- fff = 3 digit numeric Service Class
- gg..g = Data, terminated by <ESC>

Character Set

MODE	POSTAL CODE	COUNTRY CODE	SERVICE CTASS	MESSAGE LENGTH
2	9 digits max numeric only	3 digits max numeric only	3 digits max numeric only	84 characters alphanumeric
3	6 digits fixed alphanumeric	3 digits max numeric only	3 digits max numeric only	84 characters alphanumeric
4 6	“000000“ fixed data	“000“ fixed data	“000“ fixed data	91 characters alphanumeric

Notes See AIM I.S.S specification for information on the structure of this symbology.

Example
 <ESC>A<ESC>V0100<ESC>H0100
 <ESC>BV1,1,2,123456789,840,001,]<RS>01<GS>961Z01547089
 <GS>UPSN<GS>056872<GS>349<GS>99999999<GS>001/005
 <GS>029<GS>N<GS><GS>LENEXA<GS>KS<RS><EOT>
 <ESC>Q001<ESC>Z

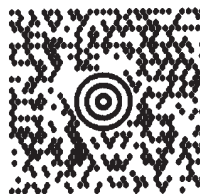

PDF417

Command Structure	<ESC>BFaabbcddeefffnnn...n
aa	= Minimum module dimension (03-09 dots). Will not print if values of 01, 02 or greater than 10 are specified.
bb	= Minimum module pitch dimension (04-24 dots). Will not print if values of 01, 02, 03 or greater than 25 are specified.
c	= Security (error detection) Level (1-8).
dd	= Code words per line (01-30). If 00 is specified for both dd and ee, the printer automatically optimizes the number of rows per symbol.
ee	= Rows per symbol (00 or 03-40). If 00 is specified for both dd and ee, the printer automatically optimizes the number of rows per symbol.
fff	= Number of characters to be encoded (0001-2700).
nn...n	= Data to be printed
g	= not specified, Standard PDF417 T Truncated PDF417 M Micro PDF417
Character Set	ASCII 128 character set plus PC437 Extended Character set.
Notes	See AIM USA Uniform Symbology Specification PDF417 for information on the structure of this symbology.
Example	<ESC>V0100<ESC>H0100<ESC>BK0607400000021PDF417 PDF417 PDF417



CODE 128 CHARACTER TABLE

The Code 128 Table lists 105 data values for the three subsets: A, B, and C. Each subset column displays either a single column of data or a double column of data.

- If the subset column displays a single column of data, that is the data to be entered to produce the result.
- If the subset column displays a double column of data, the first column contains the desired output, and the second column contains the actual characters to be entered.

For example, look at value 99 in the table:

If you are currently using Subset A or Subset B, you can change to Subset C by encoding “>C”.

VALUE	SUBSET A	SUBSET B	SUBSET C
99	Subset C >C	Subset C >C	99
100	Subset B >D	FNC4 >D	Subset B >D
101	FNC4 >E	Subset A >E	Subset A >E
102	FNC1 >F	FNC1 >F	FNC1 >F

Note: When Subset C is chosen, you must specify an even number of data positions because of the interleaved encodation method.

Code 128 Character Table

VALUE	SUBSET A	SUBSET B	SUBSET C	VALUE	SUBSET A	SUBSET B	SUBSET C
0	SP	SP	00	36	D	D	36
1	!	!	01	37	E	E	37
2	"	"	02	38	F	F	38
3	#	#	03	39	G	G	39
4	\$	\$	04	40	H	H	40
5	%	%	05	41	I	I	41
6	&	&	06	42	J	J	42
7	'	'	07	43	K	K	43
8	((08	44	L	L	44
9))	09	45	M	M	45
10	*	*	10	46	N	N	46
11	+	+	11	47	O	O	47
12	,	,	12	48	P	P	48
13	-	-	13	49	Q	Q	49
14	.	.	14	50	R	R	50
15	/	/	15	51	S	S	51
16	0	0	16	52	T	T	52
17	1	1	17	53	U	U	53
18	2	2	18	54	V	V	54
19	3	3	19	55	W	W	55
20	4	4	20	56	X	X	56
21	5	5	21	57	Y	Y	57
22	6	6	22	58	Z	Z	58
23	7	7	23	59	[[59
24	8	8	24	60	\	\	60
25	9	9	25	61]]	61
26	:	:	26	62	^	^	62
27	;	;	27	63	_	_	63
28	<	<	28	64	NUL >(space)	' >(space)	64
29	=	=	29	65	SOH >!	a >!	65
30	>	>	30	66	STX >"	b >"	66
31	?	?	31	67	ETX >#	c >#	67
32	@	@	32	68	EOT >\$	d >\$	68
33	A	A	33	69	ENQ >%	e >%	69
34	B	B	34	70	ACK >&	f >&	70
35	C	C	35	71	BEL >'	g >'	71

Code 128 Character Table (cont'd)

LUE	<i>SUBSET A</i>	SUBSET B	SUBSET C	VALUE	<i>SUBSET A</i>	SUBSET B	SUBSET C
72	BS >(h >(72	89	EM >9	y >9	89
73	HT >)	i >)	73	90	SUB >:	z >:	90
74	LF >*	j >*	74	91	ESC >;	{ >;	91
75	VT >+	k >+	75	92	FS ><	><	92
76	FF >,	l >,	76	93	GS >=	} >=	93
77	CR >-	m >-	77	94	RS >>	~ >>	94
78	SO >.	n >.	78	95	US >?	DEL >?	95
79	SI >/	o >/	79	96	FNC3 >@	FNC3 >@	96
80	DLE >0	p >0	80	97	FNC2 >A	FNC2 >A	97
81	DC1 >1	q >1	81	98	SHIFT >B	SHIFT >B	98
82	DC2 >2	r >2	82	99	Subset C >C	Subset C >C	99
83	DC3 >3	s >3	83	100	Subset B >D	FNC4 >D	Subset B >D
84	DC4 >4	t >4	84	101	FNC4 >E	Subset A >E	Subset A >E
85	NAK >5	u >5	85	102	FNC1 >F	FNC1 >F	FNC1 >F
86	SYN >6	v >6	86	103	SUBSET A START CODE >G		
87	ETB >7	w >7	87	104	SUBSET B START CODE >H		
88	CAN >8	x >8	88	105	SUBSET C START CODE >I		

APPENDIX C. CUSTOM CHARACTERS AND GRAPHICS

CUSTOM-DESIGNED CHARACTER EXAMPLE

The following example is presented to help understand the use of the Custom-Designed Characters command. It demonstrates the design and printing of an “arrow” in a 16 x 16 matrix.

1. Determine which matrix size to use
 - 16 dot x 16 dots
 - 24 dots by 24 dots

2. Lay out a grid and draw the image on the grid.
 - Each square represents one dot
 - Blacken squares for each printed dot

	1	2	3	4	5	6	7	8	1	2	3	4	5	6	7	8
1								■								
2							■	■	■							
3						■	■	■	■	■						
4					■	■	■	■	■	■	■					
5				■	■	■	■	■	■	■	■	■				
6			■	■	■	■	■	■	■	■	■	■	■			
7		■	■	■	■	■	■	■	■	■	■	■	■	■		
8	■	■	■	■	■	■	■	■	■	■	■	■	■	■	■	
1																
2																
3																
4																
5																
6																
7																
8																

- Transfer the image into two bit map representations and then into hexadecimal or binary format.

ROW	BIT MAP	HEX
1	0000 0001 0000 0000	01 00
2	0000 0011 1000 0000	03 80
3	0000 0111 1100 0000	07 C0
4	0000 1111 1110 0000	0F E0
5	0001 1111 1111 0000	1F F0
6	0011 1111 1111 1000	3F F8
7	0111 1111 1111 1100	7F FC
8	1111 1111 1111 1110	FF FE
9	0000 0111 1100 0000	07 C0
10	0000 0111 1100 0000	07 C0
11	0000 0111 1100 0000	07 C0
12	0000 0111 1100 0000	07 C0
13	0000 0111 1100 0000	07 C0
14	0000 0111 1100 0000	07 C0
15	0000 0111 1100 0000	07 C0
16	0000 0111 1100 0000	07 C0

- To store the custom designed character in memory using a hexadecimal data stream, the command would be:

```
<ESC>A
<ESC>T1H3F0100038007C00FE01FF03FF87FFCFFFE07C007C007C007C007C007C007C0
<ESC>Z
```

Note: This should be a continuous data string without any CR or LF characters.

- To recall the custom character from memory, send the following code to the printer. Note that you can print other data as well. Also note how the character size was expanded using the <ESC>L command.

```
<ESC>A
<ESC>L0505<ESC>H0150<ESC>V100<ESC>K1H903F
<ESC>L0505<ESC>H0600<ESC>V100<ESC>K1H903F
<ESC>L0303<ESC>H0125<ESC>V0250<ESC>MTHIS SIDE UP !
<ESC>Q1
<ESC>Z
```

- To store the custom designed character in memory using a binary data stream, the command would be:

```
<ESC>A
<ESC>T1B3F 01H 00H 03H 80H 07H C0H 0FH E0H 1FH F0H 3FH F8H 7FH FCH FFH FEH
07H C0H 07H C0H 07H C0H 07H C0H 07H C0H 07H C0H 07H C0H 07H C0H 07H C0H
<ESC>Z
```

NOTE: Spaces are shown between hexadecimal values in the above example for clarity only and are *not* included in the data string.

Note that the data stream is only half as long as the hexadecimal format. This is because we can send the binary equivalent of “11111111” (represented above in its hexadecimal value of FF_H), for example, using one eight bit word while it takes two eight bit words to transmit the hexadecimal equivalent “F” and “F”. To send binary characters using BASIC, the expression “CHR (&HFF) will send the binary equivalent of FF (i.e., 11111111).

6. To recall the custom character from memory, send the following code to the printer:

```
<ESC>A  
<ESC>L505<ESC>H0150<ESC>V100<ESC>K1B903F  
<ESC>L505<ESC>H0600<ESC>V100<ESC>K1B903F  
<ESC>L0303<ESC>H0125<ESC>V0250<ESC>XMTHIS SIDE UP !  
<ESC>Q1  
<ESC>Z
```

The printer output for both the hexadecimal and binary format examples is:

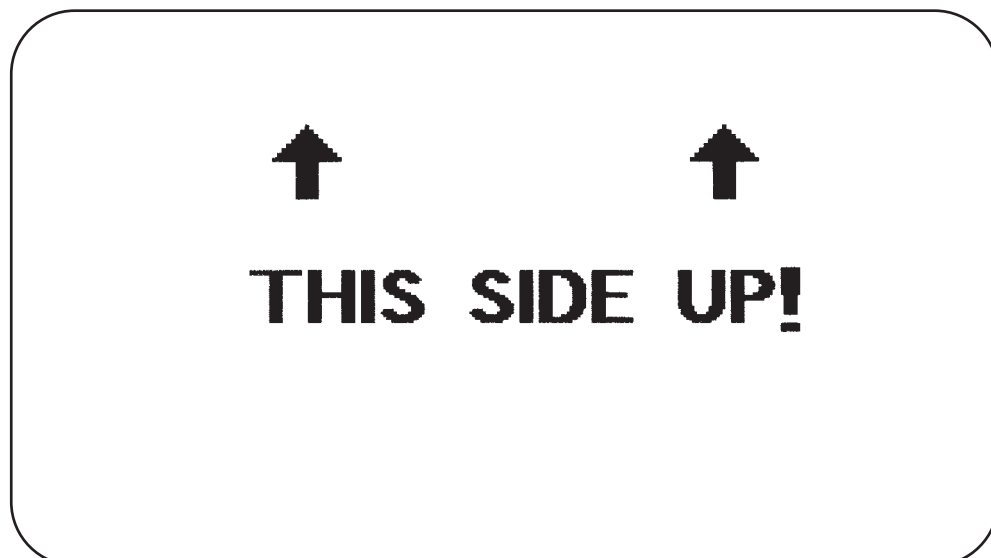

CUSTOM GRAPHICS EXAMPLE

The following example is presented to help you understand the use of the Custom Graphics command. It demonstrates the design and printing of a “diskette” in a 48 x 48 matrix.

1. Determine the matrix size for the graphic. It must be in 8 dot by 8 dot blocks. The example here has six blocks horizontally and six blocks vertically (48 x 48).
2. Lay out a grid and draw the image on the grid.
 - Each square represents one dot
 - Blacken squares for each printed dot

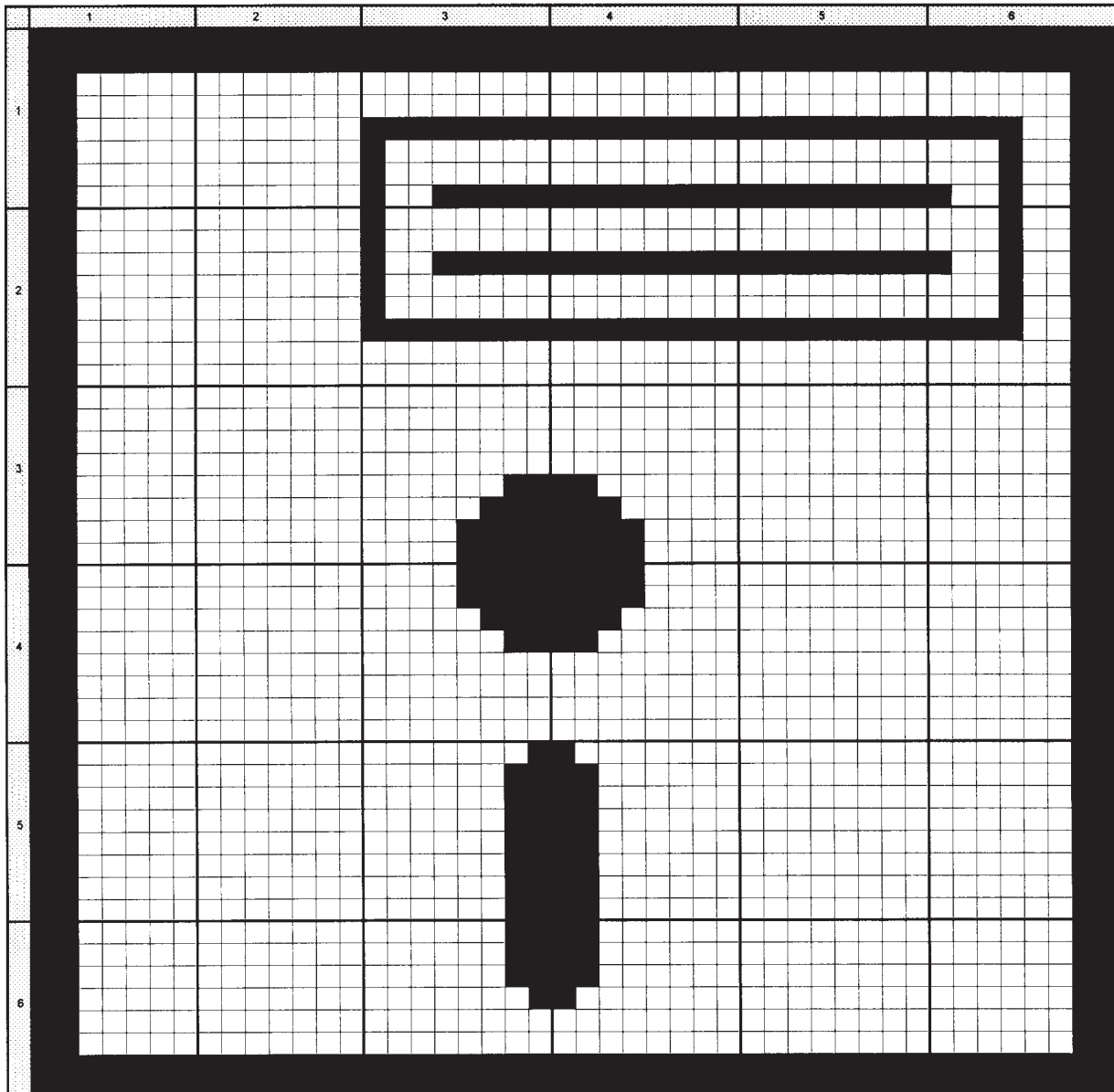

3. Transfer the image into a bit map representation and then into hexadecimal format:

BIT MAP						HEXADECIMAL FORMAT					
1	2	3	4	5	6	1	2	3	4	5	6
11111111	11111111	11111111	11111111	11111111	11111111	FF	FF	FF	FF	FF	FF
11111111	11111111	11111111	11111111	11111111	11111111	FF	FF	FF	FF	FF	FF
11000000	00000000	00000000	00000000	00000000	00000011	C0	00	00	00	00	03
11000000	00000000	00000000	00000000	00000000	00000011	C0	00	00	00	00	03
11000000	00000000	11111111	11111111	11111111	11110011	C0	00	FF	FF	FF	03
11000000	00000000	10000000	00000000	00000000	00010011	C0	00	80	00	00	13
11000000	00000000	10000000	00000000	00000000	00010011	C0	00	80	00	00	13
11000000	00000000	10011111	11111111	11111111	00010011	C0	00	9F	FF	FF	13
11000000	00000000	10000000	00000000	00000000	00010011	C0	00	80	00	00	13
11000000	00000000	10000000	00000000	00000000	00010011	C0	00	80	00	00	03
11000000	00000000	10011111	11111111	11111111	00010011	C0	00	9F	FF	FF	13
11000000	00000000	10000000	00000000	00000000	00010011	C0	00	80	00	00	13
11000000	00000000	10000000	00000000	00000000	00010011	C0	00	80	00	00	13
11000000	00000000	11111111	11111111	11111111	11110011	C0	00	FF	FF	FF	F3
11000000	00000000	00000000	00000000	00000000	00000011	C0	00	00	00	00	03
11000000	00000000	00000000	00000000	00000000	00000011	C0	00	00	00	00	03
11000000	00000000	00000000	00000000	00000000	00000011	C0	00	00	00	00	13
11000000	00000000	00000000	00000000	00000000	00000011	C0	00	00	00	00	13
11000000	00000000	00000011	11000000	00000000	00000011	C0	00	03	C0	00	03
11000000	00000000	00000111	11100000	00000000	00000011	C0	00	07	E0	00	03
11000000	00000000	00001111	11110000	00000000	00000011	C0	00	0F	F0	00	03
11000000	00000000	00001111	11110000	00000000	00000011	C0	00	0F	F0	00	03
11000000	00000000	00000111	11100000	00000000	00000011	C0	00	07	E0	00	03
11000000	00000000	00000011	11000000	00000000	00000011	C0	00	03	C0	00	03
11000000	00000000	00000000	00000000	00000000	00000011	C0	00	00	00	00	03
11000000	00000000	00000000	00000000	00000000	00000011	C0	00	00	00	00	03
11000000	00000000	00000000	00000000	00000000	00000011	C0	00	00	00	00	03
11000000	00000000	00000000	00000000	00000000	00000011	C0	00	00	00	00	03
11000000	00000000	00000000	00000000	00000000	00000011	C0	00	00	00	00	03
11000000	00000000	00000001	10000000	00000000	00000011	C0	00	01	80	00	03
11000000	00000000	00000011	11000000	00000000	00000011	C0	00	03	C0	00	03
11000000	00000000	00000011	11000000	00000000	00000011	C0	00	03	C0	00	03
11000000	00000000	00000011	11000000	00000000	00000011	C0	00	03	C0	00	03
11000000	00000000	00000011	11000000	00000000	00000011	C0	00	03	C0	00	03
11000000	00000000	00000011	11000000	00000000	00000011	C0	00	03	C0	00	03
11000000	00000000	00000011	11000000	00000000	00000011	C0	00	03	C0	00	03
11000000	00000000	00000011	11000000	00000000	00000011	C0	00	03	C0	00	03
11000000	00000000	00000001	10000000	00000000	00000011	C0	00	01	80	00	03
11000000	00000000	00000000	00000000	00000000	00000011	C0	00	03	C0	00	03
11000000	00000000	00000000	00000000	00000000	00000011	C0	00	03	C0	00	03
11000000	00000000	00000000	00000000	00000000	00000011	C0	00	01	80	00	03
11000000	00000000	00000000	00000000	00000000	00000011	C0	00	03	C0	00	03
11000000	00000000	00000000	00000000	00000000	00000011	C0	00	03	C0	00	03
11111111	11111111	11111111	11111111	11111111	11111111	FF	FF	FF	FF	FF	FF
11111111	11111111	11111111	11111111	11111111	11111111	FF	FF	FF	FF	FF	FF

- Using the hexadecimal data, send the following code to print the graphic image as designed.

```
<ESC>A<ESC>H0100<ESC>V0100<ESC>GH006006
FFFFF FFFFF FFFFF FFFFF C0000 00003
C0000 00003 C00FF FFFF3 C0080 00013
C0080 00013 C009F FFFF13 C0080 00013
C0080 00013 C009F FFFF13 C0080 00013
C0080 00013 C00FF FFFF3 C0000 00003
C0000 00003 C0000 00003 C0000 00003
C0000 00003 C0000 00003 C0003 C0003
C0007 E0003 C000F F0003 C000F F0003
C000F F0003 C000F F0003 C0007 E0003
C0003 C0003 C0000 00003 C0000 00003
C0000 00003 C0000 00003 C0001 80003
C0003 C0003 C0003 C0003 C0003 C0003
C0003 C0003 C0003 C0003 C0003 C0003
C0003 C0003 C0001 80003 C0000 00003
C0000 00003 FFFFF FFFFF FFFFF FFFFF
<ESC>Q1<ESC>Z
```

Note: Spaces shown in the hexadecimal listing above are for emphasis only. Spaces must not be encoded within the graphic portion of the data stream to the printer. Also, CR and LF characters to separate the lines must not be encoded in the data stream.

- To send the data in binary format, the software must convert the data into binary format before transmitting it to the printer. Using the BASIC programming language for example, this is done by notation “CHR\$ (&HC0)” which sends the hexadecimal value of “C0” as binary data (11000000). The BASIC program listing for sending this graphic to the printer (using the RS232 port) in binary format is:

```
CLS
OPEN "COM2:9600,N,8,1,CS,DS" FOR OUTPUT AS #1
E$ = CHR$(27)
PRINT #1,CHR$(2); E$; "A"; E$; "V0100"; E$; "H0100"; E$; "GB006006";
PRINT #1,CHR$(&HFF);CHR$(&HFF);CHR$(&HFF);CHR$(&HFF);CHR$(&HFF);
PRINT #1,CHR$(&HFF);CHR$(&HFF);CHR$(&HFF);CHR$(&HFF);CHR$(&HFF);
PRINT #1,CHR$(&HFF);CHR$(&HFF);CHR$(&HC0);CHR$(&H00);CHR$(&H00);
PRINT #1,CHR$(&H00);CHR$(&H00);CHR$(&H03);CHR$(&HC0);CHR$(&H00);
PRINT #1,CHR$(&H00);CHR$(&H00);CHR$(&H00);CHR$(&H03);CHR$(&HC0);
PRINT #1,CHR$(&H00);CHR$(&HFF);CHR$(&HFF);CHR$(&HFF);CHR$(&HF3);
PRINT #1,CHR$(&HC0);CHR$(&H00);CHR$(&H80);CHR$(&H00);CHR$(&H00);
PRINT #1,CHR$(&H13);CHR$(&HC0);CHR$(&H00);CHR$(&H80);CHR$(&H00);
PRINT #1,CHR$(&H00);CHR$(&H13);CHR$(&HC0);CHR$(&H00);CHR$(&H9F);
PRINT #1,CHR$(&HFF);CHR$(&HFF);CHR$(&H13);CHR$(&HC0);CHR$(&H00);
PRINT #1,CHR$(&H80);CHR$(&H00);CHR$(&H00);CHR$(&H13);CHR$(&HC0);
PRINT #1,CHR$(&H00);CHR$(&H80);CHR$(&H00);CHR$(&H00);CHR$(&H13);
PRINT #1,CHR$(&HC0);CHR$(&H00);CHR$(&H9F);CHR$(&HFF);CHR$(&HFF);
PRINT #1,CHR$(&H13);CHR$(&HC0);CHR$(&H00);CHR$(&H80);CHR$(&H00);
PRINT #1,CHR$(&H00);CHR$(&H13);CHR$(&HC0);CHR$(&H00);CHR$(&H80);
PRINT #1,CHR$(&H00);CHR$(&H00);CHR$(&H13);CHR$(&HC0);CHR$(&H00);
PRINT #1,CHR$(&HFF);CHR$(&HFF);CHR$(&HFF);CHR$(&HF3);CHR$(&HC0);
PRINT #1,CHR$(&H00);CHR$(&H00);CHR$(&H00);CHR$(&H00);CHR$(&H03);
PRINT #1,CHR$(&HC0);CHR$(&H00);CHR$(&H00);CHR$(&H00);CHR$(&H00);
PRINT #1,CHR$(&H03);CHR$(&HC0);CHR$(&H00);CHR$(&H00);CHR$(&H00);
PRINT #1,CHR$(&H00);CHR$(&H03);CHR$(&HC0);CHR$(&H00);CHR$(&H00);
PRINT #1,CHR$(&H00);CHR$(&H00);CHR$(&H03);CHR$(&HC0);CHR$(&H00);
PRINT #1,CHR$(&H00);CHR$(&H00);CHR$(&H00);CHR$(&H03);CHR$(&HC0);
```

```

PRINT #1,CHR$(&H00);CHR$(&H00);CHR$(&H00);CHR$(&H00);CHR$(&H03);
PRINT #1,CHR$(&HC0);CHR$(&H00);CHR$(&H03);CHR$(&HC0);CHR$(&H00);
PRINT #1,CHR$(&H03);CHR$(&HC0);CHR$(&H00);CHR$(&H07);CHR$(&H00);
PRINT #1,CHR$(&H00);CHR$(&H03);CHR$(&HC0);CHR$(&H00);CHR$(&H0F);
PRINT #1,CHR$(&HF0);CHR$(&H00);CHR$(&H03);CHR$(&HC0);CHR$(&H00);
PRINT #1,CHR$(&H0F);CHR$(&HF0);CHR$(&H00);CHR$(&H03);CHR$(&HC0);
PRINT #1,CHR$(&H00);CHR$(&H0F);CHR$(&HF0);CHR$(&H00);CHR$(&H03);
PRINT #1,CHR$(&HC0);CHR$(&H00);CHR$(&H0F);CHR$(&HF0);CHR$(&H00);
PRINT #1,CHR$(&H03);CHR$(&HC0);CHR$(&H00);CHR$(&H07);CHR$(&HE0);
PRINT #1,CHR$(&H00);CHR$(&H03);CHR$(&HC0);CHR$(&H00);CHR$(&H03);
PRINT #1,CHR$(&HC0);CHR$(&H00);CHR$(&H03);CHR$(&HC0);CHR$(&H00);
PRINT #1,CHR$(&H00);CHR$(&H00);CHR$(&H00);CHR$(&H00);CHR$(&H03);
PRINT #1,CHR$(&HC0);CHR$(&H00);CHR$(&H00);CHR$(&H00);CHR$(&H00);
PRINT #1,CHR$(&H03);CHR$(&HC0);CHR$(&H00);CHR$(&H00);CHR$(&H00);
PRINT #1,CHR$(&H00);CHR$(&H03);CHR$(&HC0);CHR$(&H00);CHR$(&H01);
PRINT #1,CHR$(&H80);CHR$(&H00);CHR$(&H03);CHR$(&HC0);CHR$(&H00);
PRINT #1,CHR$(&H03);CHR$(&HC0);CHR$(&H00);CHR$(&H03);CHR$(&HC0);
PRINT #1,CHR$(&H00);CHR$(&H03);CHR$(&HC0);CHR$(&H00);CHR$(&H03);
PRINT #1,CHR$(&HC0);CHR$(&H00);CHR$(&H03);CHR$(&HC0);CHR$(&H00);
PRINT #1,CHR$(&H03);CHR$(&HC0);CHR$(&H00);CHR$(&H03);CHR$(&HC0);
PRINT #1,CHR$(&H00);CHR$(&H03);CHR$(&HC0);CHR$(&H00);CHR$(&H03);
PRINT #1,CHR$(&HC0);CHR$(&H00);CHR$(&H03);CHR$(&HC0);CHR$(&H00);
PRINT #1,CHR$(&H03);CHR$(&HC0);CHR$(&H00);CHR$(&H03);CHR$(&HC0);
PRINT #1,CHR$(&H00);CHR$(&H03);CHR$(&HC0);CHR$(&H00);CHR$(&H03);
PRINT #1,CHR$(&HC0);CHR$(&H00);CHR$(&H03);CHR$(&HC0);CHR$(&H00);
PRINT #1,CHR$(&H01);CHR$(&H80);CHR$(&H00);CHR$(&H03);CHR$(&HC0);
PRINT #1,CHR$(&H00);CHR$(&H00);CHR$(&H00);CHR$(&H00);CHR$(&H03);
PRINT #1,CHR$(&HC0);CHR$(&H00);CHR$(&H00);CHR$(&H00);CHR$(&H00);
PRINT #1,CHR$(&H03);CHR$(&HFF);CHR$(&HFF);CHR$(&HFF);CHR$(&HFF);
PRINT #1,CHR$(&HFF);CHR$(&HFF);CHR$(&HFF);CHR$(&HFF);CHR$(&HFF);
PRINT #1,CHR$(&HFF);CHR$(&HFF);CHR$(&HFF);
PRINT #1,E$,"Q1";E$,"Z";CHR$(3)
CLOSE #1
    
```

The printer output for both the hexadecimal and binary format examples is:



This page left intentionally blank.